

# Contents

## Before driving

Introduction	2
--------------	---

Instrumentation	3
-----------------	---

Controls and features	26
-----------------------	----

Seating and safety restraints	71
-------------------------------	----

## Starting and driving

Starting	90
----------	----

Driving	95
---------	----

Roadside emergencies	109
----------------------	-----

## Servicing

Maintenance and care	126
----------------------	-----

Capacities and specifications	160
-------------------------------	-----

Reporting safety defects	166
--------------------------	-----

Index	167
-------	-----

All rights reserved. Reproduction by any means, electronic or mechanical including photocopying, recording or by any information storage and retrieval system or translation in whole or part is not permitted without written authorization from Ford Motor Company.

# Introduction

## ICONS

Indicates a warning. Read the following section on *Warnings* for a full explanation.



Indicates vehicle information related to recycling and other environmental concerns will follow.



Correct vehicle usage and the authorized disposal of waste cleaning and lubrication materials are significant steps towards protecting the environment.

## WARNINGS

Warnings provide information which may reduce the risk of personal injury and prevent possible damage to others, your vehicle and its equipment.

## BREAKING-IN YOUR VEHICLE

There are no particular breaking-in rules for your vehicle. During the first 1 600 km (1 000 miles) of driving, vary speeds frequently. This is necessary to give the moving parts a chance to break in.

If possible, you should avoid full use of the brakes for the first 1 600 km (1 000 miles).

## INFORMATION ABOUT THIS GUIDE

The information found in this guide was in effect at the time of printing. Ford may change the contents without notice and without incurring obligation.



# Instrumentation

Headlamp control  
(pg. 26)

Instrument cluster  
(pg. 6)

Turn signal and  
wiper/washer control  
(pg. 35)

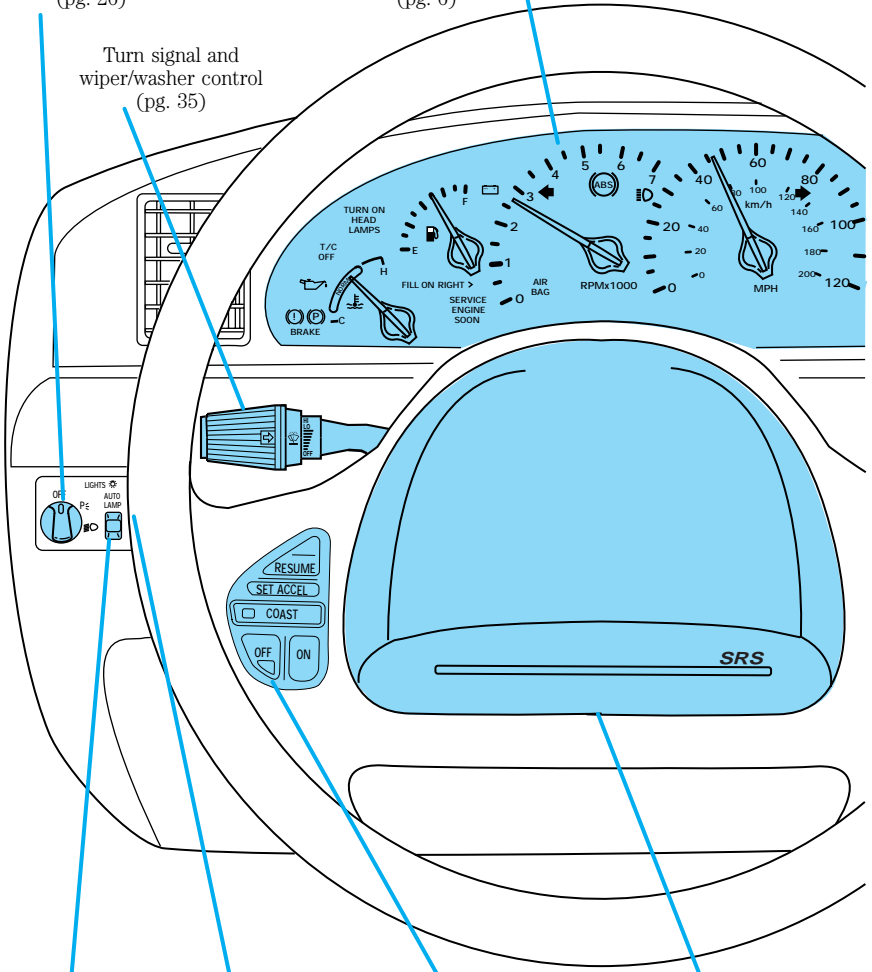

Auto lamp  
(pg. 27)

Instrument panel  
dimmer switch  
(pg. 27)

Speed control  
(pg. 36)

Driver air bag  
(pg. 80)

# Instrumentation

Electronic sound system control (pg. 35)

Message Center (pg. 12)

Clock (pg. 33)

Electronic sound system; refer to Audio Guide (pg. 33)

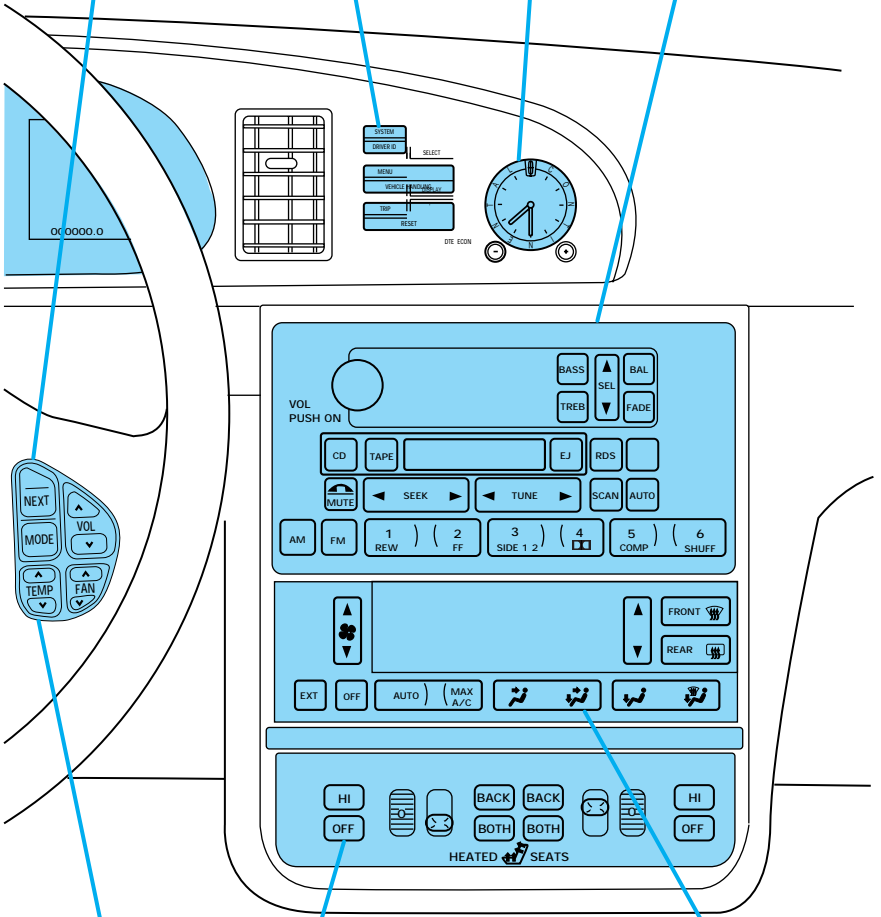

Climate controls\* (pg. 36)

Heated seat control\* (pg. 73)

Climate control systems (pg. 27)

\*if equipped

# Instrumentation

## WARNING LIGHTS AND CHIMES

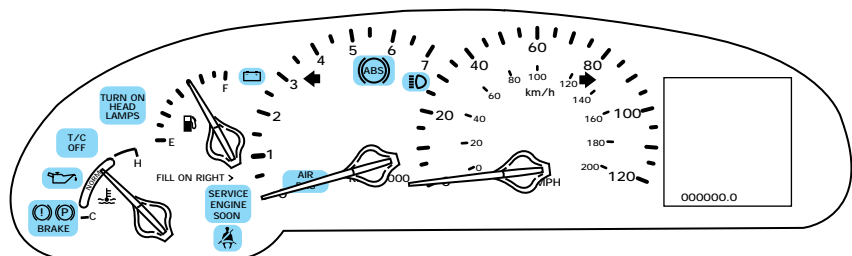

### Service engine soon

Your vehicle is equipped with a computer that monitors the engine's emission control system. This system is commonly known as the On Board Diagnostics System (OBD II). This OBD II system

protects the environment by ensuring that your vehicle continues to meet government emission standards. The OBD II system also assists the service technician in properly servicing your vehicle.

The *Service Engine Soon* indicator light illuminates when the ignition is first turned to the ON position to check the bulb. If it comes on after the engine is started, one of the engine's emission control systems may be malfunctioning. The light may illuminate without a driveability concern being noted. The vehicle will usually be drivable and will not require towing.

SERVICE  
ENGINE  
SOON

### **What you should do if the Service Engine Soon light illuminates**

#### **Light turns on solid:**

This means that the OBD II system has detected a malfunction.

Temporary malfunctions may cause your *Service Engine Soon* light to illuminate. Examples are:

1. The vehicle has run out of fuel. (The engine may misfire or run poorly.)
2. Poor fuel quality or water in the fuel.
3. The fuel cap may not have been properly installed and securely tightened.

## Instrumentation

These temporary malfunctions can be corrected by filling the fuel tank with good quality fuel and/or properly installing and securely tightening the gas cap. After three driving cycles without these or any other temporary malfunctions present, the *Service Engine Soon* light should turn off. (A driving cycle consists of a cold engine startup followed by mixed city/highway driving.) No additional vehicle service is required.

If the *Service Engine Soon* light remains on, have your vehicle serviced at the first available opportunity.

### Light is blinking:

Engine misfire is occurring which could damage your catalytic converter. You should drive in a moderate fashion (avoid heavy acceleration and deceleration) and have your vehicle serviced at the first available opportunity.



Under engine misfire conditions, excessive exhaust temperatures could damage the catalytic converter, the fuel system, interior floor coverings or other vehicle components, possibly causing a fire.

### Air bag readiness

Momentarily illuminates when the ignition is turned ON. If the light fails to illuminate, continues to flash or remains on, have the system serviced immediately.

AIR  
BAG

### Safety belt

Momentarily illuminates when the ignition is turned to the ON position to remind you to fasten your safety belts. For more information, refer to the *Seating and safety restraints* chapter.



### Brake system warning

Momentarily illuminates when the ignition is turned to the position ON and the engine is off. Also illuminates when the parking brake is engaged. Illumination after releasing the parking brake indicates low brake fluid level.



BRAKE

# Instrumentation

## Anti-lock brake system (ABS)

Momentarily illuminates when the ignition is turned to the ON position and the engine is off. If the light remains on, continues to flash or fails to illuminate, have the system serviced immediately.



## Turn signal

Illuminates when the left or right turn signal or the hazard lights are turned on. If one or both of the indicators stay on continuously or flash faster, check for a burned-out turn signal bulb. Refer to *Exterior bulbs* in the *Maintenance and care* chapter.

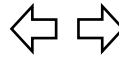

## High beams

Illuminates when the high beam headlamps are turned on.



## Turn on headlamps

Illuminates to remind the driver to turn the headlamps on when:

- the daytime running lamps are on
- the autolamps are off
- the autolamp sensor determines it is nighttime

TURN ON  
HEAD  
LAMPS

## Charging system

Momentarily illuminates when the ignition is turned to the ON position and the engine is off. The light also illuminates when the battery is not charging properly, requiring electrical system service.

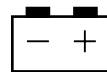



### Engine oil pressure

Illuminates when the oil pressure falls below the normal range. Stop the vehicle as soon as safely possible and switch off the engine immediately. Check the oil level and add oil if needed. Refer to *Engine oil* in the *Maintenance and Care* chapter.

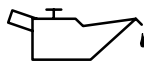

This lamp also illuminates when the ignition is turned to ON and the engine is off.

### Traction Control™ off light

Illuminates when the Traction Control™ system has been disabled (by the driver or as a result of a system failure). For more information, refer to the *Driving* chapter.

T/C  
OFF

### Safety belt warning chime

Chimes to remind you to fasten your safety belts.

For information on the safety belt warning chime, refer to the *Seating and safety restraints* chapter.

### Supplemental restraint system (SRS) warning chime

For information on the SRS warning chime, refer to the *Seating and safety restraints* chapter.

### Key-in-ignition warning chime

Sounds when the key is left in the ignition in the OFF/LOCK or ACC position and either front door is opened.

### Headlamps on warning chime

Sounds when the headlamps or parking lamps are on, the ignition is off (and the key is not in the ignition) and either front door is opened.

### Turn signal chime

Sounds when the turn signal lever has been activated to signal a turn.

# Instrumentation

## GAUGES

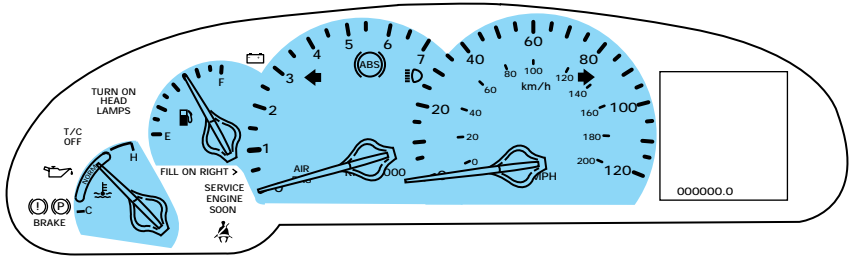

### Fuel gauge

Displays approximately how much fuel is in the fuel tank (when the fuel key is in the ON position). The fuel gauge may vary slightly when the vehicle is in motion. The ignition should be in the OFF position while the vehicle is being refueled. When the gauge first indicates empty, there is a small amount of reserve fuel in the tank. When refueling the vehicle from empty indication, the amount of fuel that can be added will be less than the advertised capacity due to the reserve fuel.

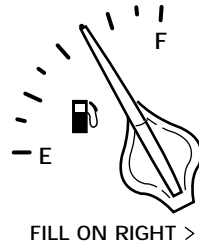

### Speedometer

Indicates the current vehicle speed.

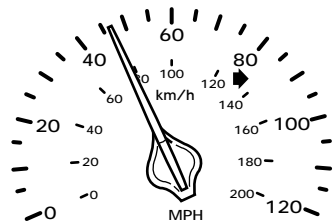

### Odometer

The odometer is located in the message center. It registers the total kilometers (miles) of the vehicle. Pressing the E/M control will alternate between English (miles) and Metric (kilometers) measurements.

## Tachometer

Indicates the engine speed in revolutions per minute.

Driving with your tachometer pointer in the red zone may damage the engine.



## Engine coolant temperature gauge

Indicates the temperature of the engine coolant. At normal operating temperature, the needle remains within the normal area (the area between the “H” and “C”). If it enters the red section, the engine is overheating. Stop the vehicle as soon as safely possible, switch off the engine immediately and let the engine cool. Refer to *Engine coolant* in the *Maintenance and care* chapter.

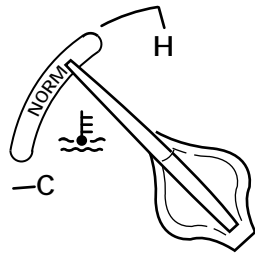

Never remove the coolant recovery cap while the engine is running or hot.

This gauge indicates the temperature of the engine coolant, not the coolant level. If the coolant is not at its proper level the gauge indication will not be accurate.

# Instrumentation

## ELECTRONIC MESSAGE CENTER

The electronic message center only works when the ignition is in the ON position.

The message center tells you about the condition of your vehicle by two methods:

- operator selectable features
- continuous warning reporting of monitored systems

You can select different features for the message center to display by using the message center controls located to the right of the instrument cluster. You will hear a tone when you press one of these controls. However, the message center will display the appropriate warning message if it detects a warning from any of the monitored systems.

If you have a vehicle with the Driver Select System, you have a DRIVER ID control in place of the E/M control.

- Refer to *DRIVER ID (if equipped)* for DRIVER ID control information.
- Refer to *E/M (if equipped)* for E/M control information.

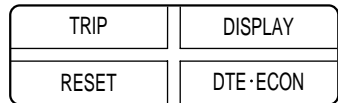
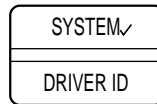
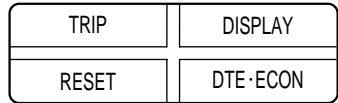
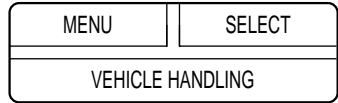
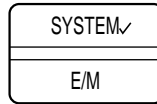

## Operator selectable features

These features are controlled by the message center controls located to the right of the instrument cluster.

### **System check**

Pressing this control causes the message center to cycle through a status of each of the systems being monitored. For each of the monitored systems, the message center will indicate either an OK message or a warning message for three seconds.

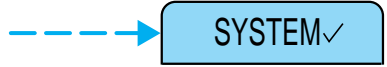

The sequence of the system check report is as follows:

- voltage level
- engine temperature
- oil level
- engine coolant level
- washer fluid level
- doors closed (driver and passenger side). This message can only be reset by closing the door(s). If the RESET control is pressed, PLEASE CLOSE DOOR will be displayed.
- trunk closed
- exterior lamps (front turn, brake and tail)
- fuel level
- distance to empty
- traction control
- ride control

### **System warnings**

System warnings alert you to possible problems or malfunctions in your vehicle's operating systems.

The message center will display the last selected feature if there are no more warning messages. This allows you to use the full functionality of the message center after you acknowledge the warning by pressing the RESET control and clearing the warning message.



## Instrumentation

Door Ajar	Cannot be reset
Driver's Door Ajar	
Check Engine Temp	Warning returns after 10 minutes
Transmission Overheat	
Check Transmission	
Low Oil Level	
Check Charging System	
Low Fuel Level	
Low Engine Coolant	
Low Tire Pressure (if equipped)	
Gear Display Data ERR	Warning reappears after key is turned from OFF to ON
Brake Lamp Out	
Check Traction Control	
Check Ride Control	
Trunk Ajar	
Check Steering Assist	
Low Washer Fluid	
Air Leveling Disabled	
Tail Lamp Out	
Check FRT Turn Lamps	
Turn on Headlamps	

Warning messages that have been reset are divided into two categories:

- They will reappear on the display ten minutes from the reset.
- They will not reappear until an ignition OFF-ON cycle has been completed. This acts as a reminder that these warning conditions still exist within the vehicle.



### **TRIP**

Press this control to display the first of two trip odometers. Press it again to display the second trip odometer.

To reset the displayed trip odometer, press the RESET control.



### **DTE/ECON**

- Press the DTE/ECON control once to display the approximately how far you can drive before running out of fuel, or the distance to empty (DTE). To ensure accuracy, turn the ignition OFF when you fill the tank. 
- Press the DTE/ECON control a second time to display the average fuel economy in liters/100 kilometers or miles/gallon, based on distance traveled and rate of fuel used information.
- To reset this feature, press the RESET control while average fuel economy is displayed (while you are driving). 

DTE is calculated using a running average fuel economy initialized by the factory. This value is not the same as the average fuel economy display. The running average fuel economy is based on more than 800 kilometers (500 miles) of driving history, and is reinitialized if the battery is disconnected.

If the FUEL LEVEL ERROR message is displayed, there is a problem with the fuel indication system and you should contact your dealer for service as soon as possible.

### **E/M (if equipped)**

Press this control to switch the odometer and the message center display from metric (kilometers) to English (miles) units, and to change the temperature indication on the climate control unit. 

### **DRIVER ID (if equipped)**

Press this control to set vehicle comfort settings for up to two drivers. Seat and mirror position and vehicle handling characteristics can be set with this control. 

## Instrumentation

### **RESET**

Press this control to reset:

- warnings
- average fuel economy
- trip odometers

The other selectable features are unaffected by pressing RESET.



### **DISPLAY**

Press this control to turn the message center display off. Press it again to turn the display on. Warnings override an off display and must be reset for the display to be off again.



### **VEHICLE HANDLING**

Press this control once to adjust RIDE CONTROL SETTINGS (if equipped) between NORMAL, PLUSH and FIRM. This feature cannot be adjusted on vehicles not equipped with the Driver Select System.

Press this control a second time to adjust the STEERING EFFORT SETTINGS between NORMAL, LOW and HIGH.

Press the SELECT control to change these settings while in VEHICLE HANDLING mode. The combination of firm ride control (if equipped) and low steering effort is undesirable and cannot be selected.

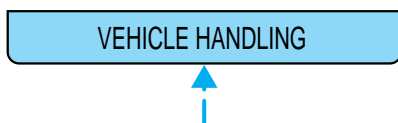

### **MENU**

Press this control to change various convenience settings throughout the vehicle. Each press of the MENU control will display a different convenience setting as follows:

#### **Save to driver (if equipped)**

This allows you to select driver setting one, two or off.





### ***Traction control***

Refer to *Traction Control*<sup>™</sup> for more information.

### ***Express window***

- Standard vehicle setting is saved as vehicle setting only (not the Driver 1 or 2 individualized profiles).
- Standard vehicle with Memory Profile System: setting may be saved to either Driver 1 or 2 personalized profiles or as a vehicle setting.
- Settings: ON or OFF.
- Original setting: ON.
- Setting adjustment is made using the message center MENU/SELECT controls.

### ***Auto door locks***

- Standard vehicle: setting is saved as vehicle setting only (not the Driver 1 or 2 individualized profiles).
- Standard vehicle with Memory Profile System: setting may be saved to either the Driver 1 or 2 personalized profiles or as a vehicle setting.
- Settings: ON or OFF.
- Original setting: ON.
- Setting adjustment is made using the message center MENU/SELECT controls.

### ***Horn chirp***

- Standard vehicle: setting is saved as vehicle setting only (not the Driver 1 or 2 individualized profiles).
- Standard vehicle with Memory Profile System: setting may be saved to either the Driver 1 or 2 personalized profiles or as a vehicle setting.
- Settings: ON or OFF.
- Original setting: ON.
- Setting adjustment is made using the message center MENU/SELECT controls.

### ***Easy entry/exit seat access***

- Standard vehicle: setting is saved as vehicle setting only (not the Driver 1 or 2 individualized profiles).

## Instrumentation

- Standard vehicle with Memory Profile System: setting may be saved to either the Driver 1 or 2 personalized profiles or as a vehicle setting.
- Settings: ON or OFF.
- Original setting: ON.
- Setting adjustment is made using the message center MENU/SELECT controls.

### ***Reverse mirrors***

- Standard vehicle: setting is saved as vehicle setting only (not the Driver 1 or 2 individualized profiles).
- Standard vehicle with Memory Profile System: setting may be saved to either the Driver 1 or 2 personalized profiles or as a vehicle setting.
- Settings: ON or OFF.
- Original setting: ON.
- Setting adjustment is made using the message center MENU/SELECT controls.

### ***Adjustable ride***

- Standard vehicle: not available.
- Standard vehicle with Memory Profile System: setting may be saved to either the Driver 1 or 2 personalized profiles or as a vehicle setting.
- Settings: plush, normal or firm.
- Original setting: normal.
- Setting adjustment is made using the message center VEHICLE HANDLING/SELECT controls.

### ***Adjustable steering***

- Standard vehicle: setting is saved as vehicle setting only (not the Driver 1 or 2 individualized profiles).
- Standard vehicle with Memory Profile System: setting may be saved to either the Driver 1 or 2 personalized profiles or as a vehicle setting.
- Settings: low, normal or high.
- Original setting: normal.
- Setting adjustment is made using the message center VEHICLE HANDLING/SELECT controls.

### ***Autolamp on/delay time***

Standard vehicle with Memory Profile System: setting may be saved to either the Driver 1 or 2 personalized profiles or as a vehicle setting.

### ***Instrument panel dim control setting***

- Standard vehicle: setting is saved as vehicle setting only (not the Driver 1 or 2 individualized profiles).
- Standard vehicle with Memory Profile System: setting may be saved to either the Driver 1 or 2 personalized profiles or as a vehicle setting.
- Settings: variable.
- Original setting: maximum.
- Setting adjustment is made using the lighting control module-panel dim control.

### ***Driver's seat position***

- Setting may be saved to either the Driver 1 or 2 personalized profiles or as a vehicle setting.
- Settings: 8-way adjustment.
- Original setting: N/A.
- Setting adjustment is made using the driver seat control.

### ***Outside mirror position***

- Setting may be saved to either the Driver 1 or 2 personalized profiles or as a vehicle setting.
- Settings: horizontal and vertical.
- Original setting: N/A.
- Setting adjustment is made using the outside mirror control.

## **DRIVER PROFILE SYSTEM (IF EQUIPPED)**

The Driver profile System allows for two primary drivers to save their individual seat and outside rearview mirror position preferences. The feature will then be set to the individual's preferences when that individual identifies themselves to the system before entering the vehicle.

The Message Center info allows the driver to program eight vehicle features (listed in Driver Profile features) according to their driving preferences. These feature preferences will be saved as the vehicle

## Instrumentation

settings (not individualized settings). To change a feature setting see *Driver profile features* in this section.

### Associated systems

#### **Keyless Entry System**

Programming personalized codes:

With a key and/or Key FOB outside of the vehicle:

- Enter the factory code
- Press the 1/2 control
- Enter the five digit personalized code

Press:

- The 1/2 control to save the code as Driver 1.
- The 3/4 control to save the code as Driver 2.
- The 5/6 control to save as a third code that will not identify the driver to the System and turn the system OFF.
- When the desired codes have been entered, press the 7/8 and 9/0 controls simultaneously to end programming, and to lock all of the doors.
- Test the programmed codes by entering them and verifying the driver's door unlocks. Press 7/8 and 9/0 simultaneously to lock all of the doors. Repeat for other codes as required.

#### **The Message Center System**

The Message Center is used to display Driver Profile messages and warning and program many of the Driver Profile System features. Press the following controls for desired programming:

- The MENU control will display options for the Express Window, Auto Door Locks, Horn Chirp, Easy Entry/Exit Seat Access and Reverse Mirror features which can be set by using the SELECT control.
- The VEHICLE HANDLING control will display options for Adjustable Steering and Adjustable Ride (DSS only) features which can be set using the SELECT control.
- The DRIVER ID control will display the option of selecting Driver 1, Driver 2 or OFF.

## Driver profile features

### ***Express window***

- Standard vehicle-setting is saved as vehicle setting only (not the DRIVER MEMORY 1 or 2 individualized profiles).
- Standard vehicle with Memory Profile System-setting may be saved to either the DRIVER MEMORY 1 or 2 personalized profiles or as a vehicle setting.
- Settings-ON or OFF
- Original setting-ON
- Setting adjustment made using: Message Center-MENU/SELECT controls

### ***Auto door locks***

- Standard vehicle-setting is saved as vehicle setting only (not the DRIVER MEMORY 1 or 2 individualized profiles).
- Standard vehicle with Memory Profile System-setting may be saved to either the DRIVER MEMORY 1 or 2 personalized profiles or as a vehicle setting.
- Settings-ON or OFF
- Original setting-ON
- Setting adjustment made using: Message Center-MENU/SELECT controls

### ***Horn chirp***

- Standard vehicle-setting is saved as vehicle setting only (not the DRIVER MEMORY 1 or 2 individualized profiles).
- Standard vehicle with Memory Profile System-setting may be saved to either the DRIVER MEMORY 1 or 2 personalized profiles or as a vehicle setting.
- Settings-ON or OFF
- Original setting-ON
- Setting adjustment made using: Message Center-MENU/SELECT controls

## Instrumentation

### ***Easy entry/exit seat access***

- Standard vehicle-setting is saved as vehicle setting only (not the DRIVER MEMORY 1 or 2 individualized profiles).
- Standard vehicle with Memory Profile System-setting may be saved to either the DRIVER MEMORY 1 or 2 personalized profiles or as a vehicle setting.
- Settings-ON or OFF
- Original setting-ON
- Setting adjustment made using: Message Center-MENU/SELECT controls

### ***Reverse mirrors***

- Standard vehicle-setting is saved as vehicle setting only (not the DRIVER MEMORY 1 or 2 individualized profiles).
- Standard vehicle with Memory Profile System-setting may be saved to either the DRIVER MEMORY 1 or 2 personalized profiles or as a vehicle setting.
- Settings-ON or OFF
- Original setting-ON
- Setting adjustment made using: Message Center-MENU/SELECT controls

### ***Adjustable ride***

- Standard vehicle-not available.
- Standard vehicle with Memory Profile System-setting may be saved to either the DRIVER MEMORY 1 or 2 personalized profiles or as a vehicle setting.
- Settings-plush, normal, firm
- Original setting-normal
- Setting adjustment made using: Message Center-VEHICLE HANDLING/SELECT controls

### ***Adjustable steering***

- Standard vehicle-setting is saved as vehicle setting only (not the DRIVER MEMORY 1 or 2 individualized profiles).

- Standard vehicle with Memory Profile System-setting may be saved to either the DRIVER MEMORY 1 or 2 personalized profiles or as a vehicle setting.
- Settings-low, normal, high
- Original setting-normal
- Setting adjustment made using: Message Center-VEHICLE HANDLING/SELECT controls

### ***Autolamp on/delay time***

- Standard vehicle with Memory Profile System-setting may be saved to either the DRIVER MEMORY 1 or 2 personalized profiles or as a vehicle setting.

### ***Instrument panel dim control setting***

- Standard vehicle-setting is saved as vehicle setting only (not the DRIVER MEMORY 1 or 2 individualized profiles).
- Standard vehicle with Memory Profile System-setting may be saved to either the DRIVER MEMORY 1 or 2 personalized profiles or as a vehicle setting.
- Settings-variable
- Original setting-maxium
- Setting adjustment made using: Lighting Control Module-panel dim control.

### ***Driver's seat position***

- Standard vehicle-setting may be saved to either the DRIVER MEMORY 1 or 2 personalized profiles or as a vehicle setting.
- Standard vehicle with Memory Profile System-setting may be saved to either the DRIVER MEMORY 1 or 2 personalized profiles or as a vehicle setting.
- Settings-8-way adjustment
- Original setting-N/A
- Setting adjustment made using: driver seat control

### ***Outside mirror position***

- Standard vehicle-setting may be saved to either the DRIVER MEMORY 1 or 2 personalized profiles or as a vehicle setting.

## Instrumentation

- Standard vehicle with Memory Profile System-setting may be saved to either the DRIVER MEMORY 1 or 2 personalized profiles or as a vehicle setting.
- Settings-horizontal and vertical
- Original setting-N/A
- Setting adjustment made using: outside mirror control

### Basic operation

In order for the system to be able to store or recall an individuals seat or mirror position preferences, the Driver Profile System must first recognize who will be driving the vehicle. Drivers may identify themselves to the system one of two ways:

- Pressing the unlock control on the appropriate Key FOB (DRIVER MEMORY 1 or DRIVER MEMORY 2 Key FOB is identified by the number on the back of the Key FOB) before opening the driver's door.
- Entering either the DRIVER MEMORY 1 or DRIVER MEMORY 2 personalized code into the keyless entry keypad before opening the driver's door. For information on programming personalized codes see *Keyless entry system* in this section.

Pressing OFF will turn the system off.

Once the system has identified the driver (DRIVER MEMORY 1 or DRIVER MEMORY 2), the seat and mirror will automatically begin to move to that driver profile. Changes made to the seat or mirror positions will automatically be saved to that profile.

If the driver should enter the vehicle without first identifying themselves, all features will remain at their last setting or position and any settings will be saved as vehicle settings not individualized settings.

If Driver 1 or Driver 2 wishes to make temporarily changes to their seat or outside mirror positions without affecting their preferred positions they may do so by:

- Using the switch on the back of the Key FOB to turn the Driver Profile System OFF prior to pressing the unlock control on the Key FOB.
- Entering the vehicle without identifying themselves using the two methods listed above.

This option may be useful to temporarily reposition the driver's seat and mirrors during an extended drive.



### Memory Profile System (if equipped)

The Memory Profile System allows the two primary drivers to select and save individualized preferences for the following eleven vehicle features:

- Express window
- Auto door locks
- Horn chirp
- Easy entry/exit seat access
- Reverse mirrors
- Adjustable ride
- Adjustable steering
- Autolamp on/delay time
- Instrument panel dim control
- Driver's seat position
- Outside mirror position

Basic Operation of the Driver Profile System with Memory Profile System is the same, with the added option of being able to identify who is driving the vehicle by using the Message Center controls. Refer to “Message Center” in the *Instrumentation* chapter for more information on the Message Center controls. The Message Center has a Driver ID control, which when pressed, allows the driver to select either Driver 1, Driver 2 or OFF. Selecting OFF will turn the system OFF.

## Controls and features

### HEADLAMP CONTROL

Rotate the headlamp control to the first position to turn on the parking lamps only. Rotate to the second position to also turn on the headlamps.

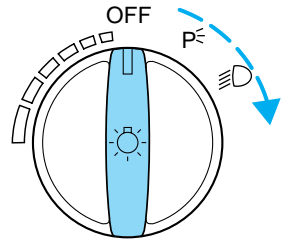

### Daytime running lamps (DRL) (if equipped)

Turns the highbeam headlamps on with a reduced output. To activate:

- the engine must be running
- the headlamp control is in the OFF or Parking lamps position.



The Daytime Running Light (DRL) system will not illuminate the tail lamps and parking lamps. Turn on your headlamps at dusk. Failure to do so may result in a collision.

### High beams

Push forward to activate.

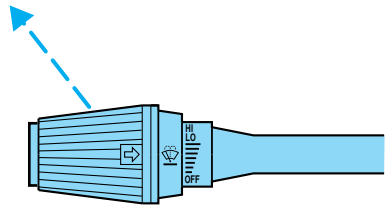

### Flash to pass

Pull toward you to activate and release to deactivate.

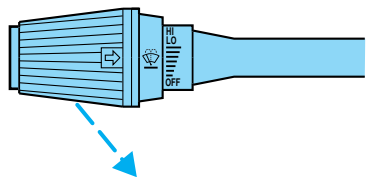

# Controls and features

## INSTRUMENT PANEL DIMMER CONTROL

Use to adjust the brightness of the instrument panel during headlight and parklamp operation.

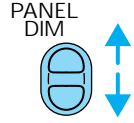

- Push up to brighten.
- Push down to dim.

## AUTOLAMP CONTROL

The autolamp system provides light sensitive automatic on-off control of the exterior lights normally controlled by the headlamp control.

The autolamp system also keeps the lights on for a preselected period of time after the ignition switch is turned to OFF.

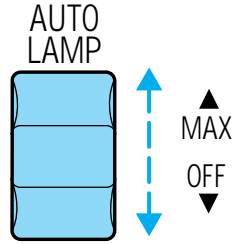

- To turn autolamps on, push the control up toward the MAX position. As you press this switch, the autolamp system's status will be displayed in the message center. The system can be set to provide light for up to three minutes after you turn the ignition OFF.
- To turn autolamps off, push the control down toward OFF.

## CLIMATE CONTROL SYSTEM

### Electronic Automatic Temperature Control (EATC) system

The EATC system will maintain a selected temperature and automatically control airflow. You can override automatic operation with any of the override controls, the fan speed control or the steering wheel controls (if equipped).

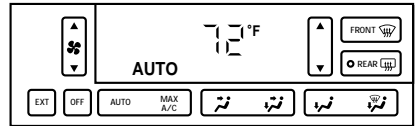

### Turning the EATC on

Press AUTO, any of the override controls or the fan speed control. The EATC will only operate when the ignition is in the ON position.

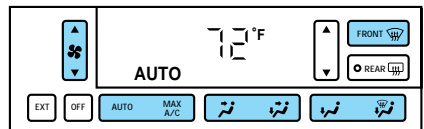

## Controls and features

### Turning the EATC off

Press OFF. The Outside Temperature (EXT) function will continue to operate until the ignition is turned off.

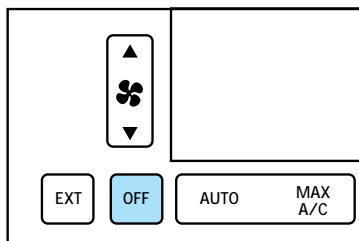

### Automatic operation

Press AUTO and select the desired temperature. The selected temperature and the word AUTO will appear in the display window. The EATC system will either heat or cool to achieve the selected temperature. The system will automatically determine fan speed, airflow location and if fresh outside air or recirculated air is required. Fan speed remains automatic unless the fan speed control is pressed or the steering wheel controls (if equipped) are pressed.

When in AUTO and weather conditions require heat, air will be sent to the floor. However, if the engine is not warm enough to provide heat, the fan will not operate. In 3½ minutes or less, the fan speed will start to increase and the airflow location will change to the floor area.

If unusual conditions exist (i.e.-window fogging, etc.), the manual override controls allow you to select airflow locations and the fan control allows you to adjust fan speed as necessary.

### Temperature selection

The display window indicates the selected temperature, function (AUTO or one of the override controls) and manual control of fan speed (☼) if automatic fan speed is not desired.



## Controls and features

To control the temperature, select any temperature between 18°C (65°F) and 29°C (85°F) by pressing the temperature control.

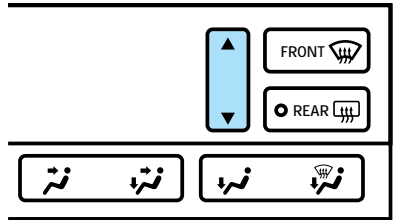

For continuous maximum cooling, push the temperature control until 16°C (60°F) is shown in the display window. The EATC will continue maximum cooling (disregarding the displayed temperature) until a warmer temperature is selected by pressing the temperature control.

For continuous maximum heating, push the temperature control until 32°C (90°F) is shown in the display window. The EATC will continue maximum heating (disregarding the displayed temperature) until a cooler temperature is selected by pressing the temperature control.

### Temperature conversion

Press MAX A/C and FRONT  at the same time (for one second) to switch between Fahrenheit and Celsius.

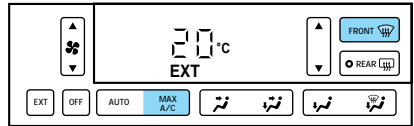

Your vehicle has an English/Metric (E/M) control to change your electronic message center display from English to Metric. This control will also change the temperature display. Refer to *Electronic Message Center* in the *Instrumentation* chapter.

### Fan speed

When AUTO is pressed, fan speed is adjusted automatically for existing conditions. You can override fan speed at any time. To control fan speed manually, press the fan control or the steering wheel fan speed control to cancel automatic fan speed operation. Press the control up for higher fan speed or down for lower fan speed. Press the

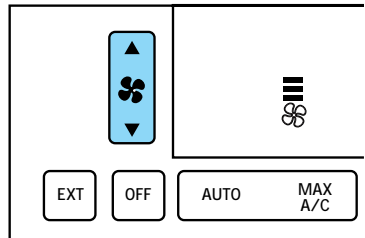

## Controls and features

steering wheel control up for higher fan speed or down for lower fan speed.

The display will show  and a bar graph to indicate manual fan operation and relative speed.





To return to automatic fan operation, press AUTO.

### Manual override controls

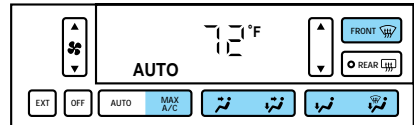

The override controls allow you to determine where airflow is directed. To return to full automatic control, press AUTO.



The air conditioning compressor will operate in all modes except  and . It will also operate only when required when AUTO has been selected. However, the air conditioning will only function if the outside temperature is about 10°C (50°F) or above.



Since the air conditioner removes considerable moisture from the air during operation, it is normal if clear water drips on the ground under the air conditioner drain while the system is working and even after you have stopped the vehicle.

Under normal conditions, your vehicle's climate control system should be left in any position other than MAX A/C or OFF when the vehicle is parked. This allows the vehicle to "breathe" through the outside air inlet duct.

- MAX A/C-Uses recirculated air to cool the vehicle. The temperature will display 16°C (60°F). To exit, press AUTOMATIC or any other override controls. MAX A/C is noisier than normal A/C but more economical and will cool the inside of the vehicle faster. Airflow is from the instrument panel registers. This mode can also be used to prevent undesirable odors from entering the vehicle.
-  -Distributes outside air through the instrument panel registers. However, the air cannot be cooled below the outside temperature because the air conditioning does not operate in this mode.
-  -Distributes outside air through the instrument panel registers and the floor ducts. Heating and air conditioning capabilities are

## Controls and features

provided in this mode. The air will be heated or cooled based on the temperature selection. For added customer comfort, the air distributed through the floor ducts will be slightly warmer than the air sent to the instrument panel registers.

-  -Allows for maximum heating by distributing outside air through the floor ducts. However, the air cannot be cooled below the outside temperature because the air conditioning does not operate in this mode.
-  -Distributes outside air through the windshield defroster ducts and the floor ducts. Heating and air conditioning capabilities are provided in this mode. The air will be heated or cooled based on the temperature selection. For added customer comfort, the air distributed through the floor ducts will be slightly warmer than the air sent to the windshield defroster ducts. If the temperature is about 10°C (50°F) or higher, the air conditioner will automatically dehumidify the air to prevent fogging.
- FRONT  -Distributes outside air through the windshield defroster ducts. It can be used to clear ice or fog from the windshield. If the outside air temperature is about 10°C (50°F) or higher, the air conditioner will automatically dehumidify the air to prevent fogging.
- OFF-Outside air is shut out and the fan will not operate. For short periods of time only, use this mode to prevent undesirable odors from entering the vehicle.

### Displaying outside temperature

Press EXT to display the outside air temperature. It will be displayed until EXT is pressed again.

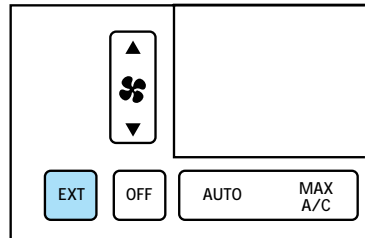

If the selected temperature is changed while the outside temperature is displayed, the new temperature will be displayed for four seconds after it is changed, then the outside temperature will return to the window.

If a manual override function is selected while the outside temperature is displayed, the new function will be displayed for four seconds after it is

## Controls and features

changed, then the outside temperature will return to the window along with the override selection.

The outside temperature reading is most accurate when the vehicle is moving. Higher readings may be obtained when the vehicle is not moving. The readings that you get may not agree with temperatures given on the radio due to differences in vehicle and station locations.

### **Operating tips**

- In humid weather, select FRONT  before driving. This will prevent your windshield from fogging. After a few minutes, select any desired position.
- To prevent humidity buildup inside the vehicle, don't drive with the climate control system in the OFF position.
- Don't put objects under the front seat that will interfere with the airflow to the back seats.
- Remove any snow, ice or leaves from the air intake area (at the bottom of the windshield).

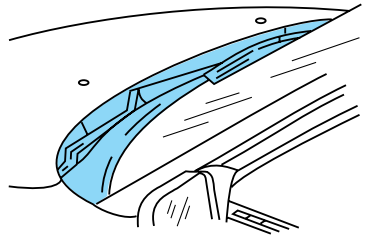

- If your vehicle has been parked with the windows closed during hot weather, the air conditioner will do a much faster job of cooling if you drive for two or three minutes with the windows open. This will force most of the hot, stale air out of the vehicle. Then operate the air conditioner as you would normally.
- If the air conditioner works well in MAX A/C but not in normal A/C, this may indicate that the cabin air filter (if equipped) needs to be replaced.
- When placing objects on top of your instrument panel, be careful to not place them over the defroster outlets. These objects can block airflow and reduce your ability to see through your windshield. Also, avoid placing small objects on top of your instrument panel. These objects can fall down into the defroster outlets and block airflow and possibly damage your climate control system.



## Controls and features

The rear defroster control is located on the instrument panel.

Press the defroster control to clear the rear window of thin ice and fog.

- The small LED will illuminate when the defroster is activated.

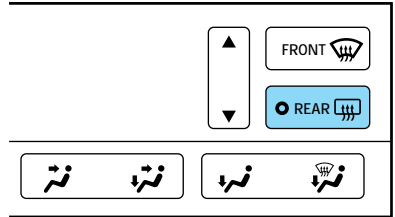

The ignition must be in the ON position to operate the rear window defroster.

The defroster turns off automatically after 10 minutes or when the ignition is turned to the OFF position. To manually turn off the defroster before ten minutes have passed, push the control again.

### CLOCK (IF EQUIPPED)

Press + to increase the time displayed.

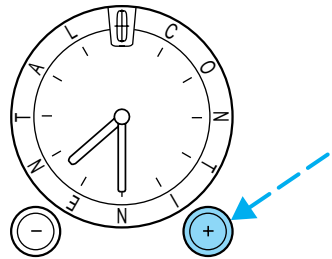

Press - to decrease the time displayed.

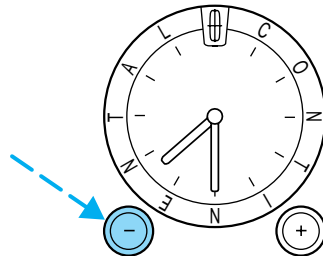

### AUDIO SYSTEM

Refer to the “Audio Guide” for instructions on how to operate the audio system.

# Controls and features

## POSITIONS OF THE IGNITION

1. **ACCESSORY**, allows the electrical accessories such as the radio to operate while the engine is not running.
2. **LOCK**, locks the steering wheel, automatic transmission gearshift lever and allows key removal.
3. **OFF**, shuts off the engine and all accessories without locking the steering wheel.
4. **ON**, all electrical circuits operational. Warning lights illuminated. Key position when driving.
5. **START**, cranks the engine. Release the key as soon as the engine starts.

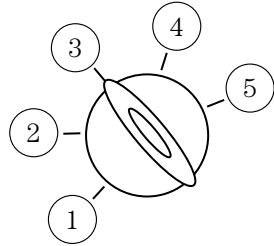

## WINDSHIELD WIPER/WASHER CONTROLS

Rotate the windshield wiper control to the desired interval, low or high speed position.

The bars of varying length are for intermittent wipers. When in this position rotate the control upward for fast intervals and downward for slow intervals.

Push the control on the end of the stalk to activate washer. Push and hold for a longer wash cycle.

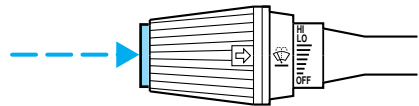
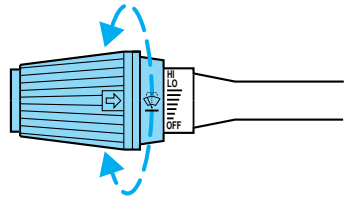

## Windshield wiper/washer features

The exterior lamps will illuminate when the ignition is ON and the windshield wiper control is in the interval, LO or HI position.

The instrument panel lighting will dim noticeably approximately 15 seconds after the wipers are turned on. The lights will remain in this state until 30 seconds after the wipers are turned off.

## Controls and features

### TURN SIGNAL CONTROL

- Push down to activate the left turn signal.
- Push up to activate the right turn signal.

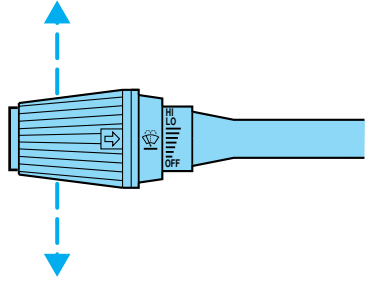

### Cornering lamps (if equipped)

When the turn signal is used when the headlamps are on, the cornering lamps will light either the right or left side depending on the direction of the turn.

The flash rate of the turn signal will speed up considerably if the Lighting Control Module detects a left or right turn lamp bulb (front or rear) is burned out.

### STEERING WHEEL CONTROLS (IF EQUIPPED)

#### Radio control features

- Press MEM/NEXT to select a preset station from memory.
- Press BAND/MODE to select AM, FM1, FM2, TAPE or CD (if equipped).
- Press VOL up or down to adjust the volume.

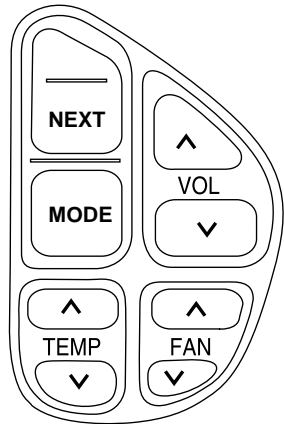

## Controls and features

### ***Speed sensitive volume***

The recommended level for speed sensitive volume is from level 1 through level 3. Level 0 turns the speed sensitive volume off and Level 7 is the maximum setting for the speed sensitive volume.

### **Climate control features**

- Press TEMP up or down to adjust temperature.
- Press FAN up or down to adjust fan speed.

## **SPEED CONTROL**

### **To turn speed control on**

- Press ON.

Vehicle speed cannot be controlled until the vehicle is traveling at or above 48 km/h (30 mph).

When the ON control is pressed, the message “SPEED CONTROL READY” will appear for 5 seconds in your message center. Or, if the speed control is already ON and SET, the message “SPEED CONTROL SET” will appear for 5 seconds in your message center.

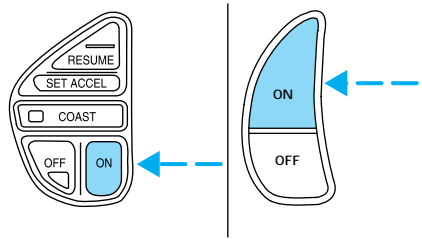

Do not use the speed control in heavy traffic or on roads that are winding, slippery, or unpaved.



Do not shift the gearshift lever into N (Neutral) with the speed control on.

## Controls and features

### To turn speed control off

- Press OFF or
- Turn off the vehicle ignition.

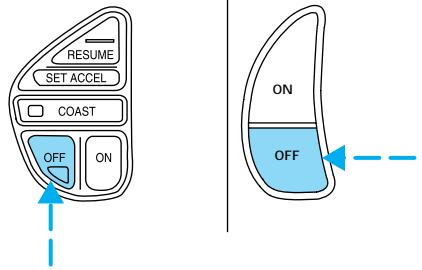

Once speed control is switched off, the previously programmed set speed will be erased.

When the OFF control is pressed, the message “SPEED CONTROL OFF” will appear for 5 seconds in your message center.

### To set a speed

- Press SET ACC/SET ACCEL. For speed control to operate, the speed control must be ON and the vehicle speed must be greater than 48 km/h (30 mph).

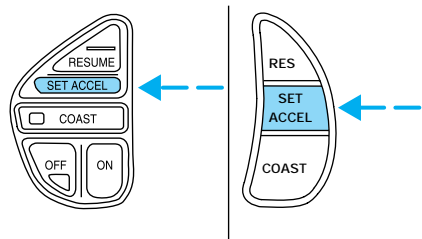

When the SET ACCEL control is pressed, the message “SPEED CONTROL SET” will appear for 5 seconds in your message center.

If you drive up or down a steep hill, your vehicle speed may vary momentarily slower or faster than the set speed. This is normal.

Speed control cannot reduce the vehicle speed if it increases above the set speed on a downhill. If your vehicle speed is faster than the set speed while driving on a downhill, you may want to shift to the next lower gear or apply the brakes to reduce your vehicle speed.

If your vehicle slows down more than 16 km/h (10 mph) below your set speed on an uphill, your speed control will disengage. “SPEED CONTROL CANCELED” will appear for 5 seconds in your message center. This is normal. Pressing RES/RSM/RESUME will re-engage it.

## Controls and features



Do not use the speed control in heavy traffic or on roads that are winding, slippery, or unpaved.

### To set a higher set speed

- Press and hold SET ACC/SET ACCEL. Release the control when the desired vehicle speed is reached or
- Press and release SET ACC/SET ACCEL. Each press will increase the set speed by 1.6 km/h (1 mph) if (E) English is selected or 2 km/h (1.25mph) if (M) Metric is selected in the Message Center.
- Accelerate with your accelerator pedal, then press and release SET ACC/SET ACCEL.

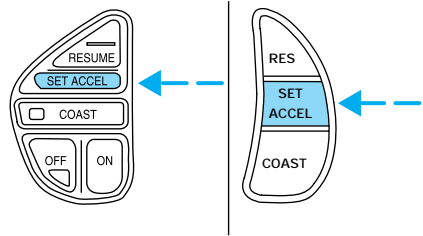

When the SET ACCEL control is pressed and released, the message “SPEED CONTROL SET” will appear for 5 seconds in your message center.

You can accelerate with the accelerator pedal at any time during speed control usage. Releasing the accelerator pedal will return your vehicle to the previously programmed set speed.

### To set a lower set speed

- Press and hold CST/COAST. Release the control when the desired speed is reached or
- Press and release CST/COAST. Each press will decrease the set speed by 1.6 km/h (1 mph) if (E) English is selected or 2km/h (1.25 mph) if (M) Metric is selected in the Message Center.

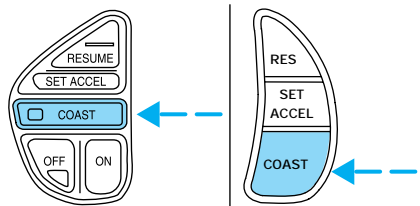

## Controls and features

- Depress the brake pedal. When the desired vehicle speed is reached, press SET ACC/SET ACCEL.

When the COAST or SET ACCEL control is pressed and released, the message “SPEED CONTROL SET” will appear for 5 seconds in your message center.

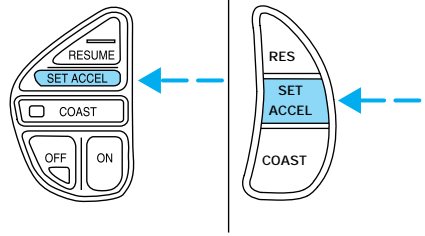

### To disengage speed control

- Depress the brake pedal.

When the brake pedal is depressed, the message “SPEED CONTROL CANCELED” will appear for 5 seconds in your message center.

Disengaging the speed control will not erase the previously programmed set speed.

- Press the OFF control.

Pressing OFF will erase the previously programmed set speed.

When the OFF control is pressed, the message “SPEED CONTROL OFF” will appear for 5 seconds in your message center.

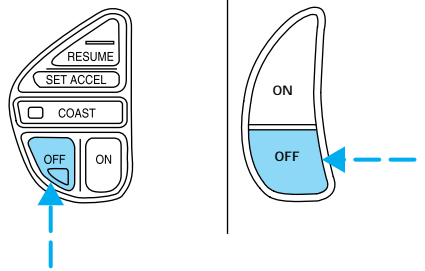

### To return to a previously set speed

- Press RES/RSM/RESUME. For RES/RSM/RESUME to operate, the vehicle speed must be faster than 48 km/h (30 mph).

When the RESUME control is pressed, the message “SPEED CONTROL SET” will appear for 5 seconds in your message center.

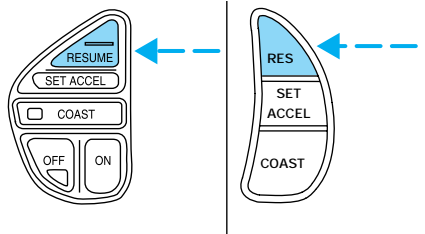

## Controls and features

### TILT STEERING

Pull the tilt steering control toward you to move the steering wheel up or down. Hold the control while adjusting the wheel to the desired position, then release the control.

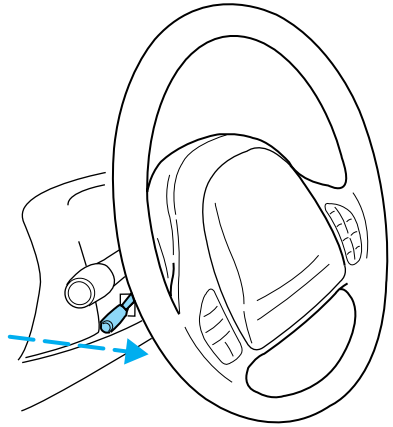

Never adjust the steering wheel when the vehicle is moving.

### INTERIOR LAMPS

#### Map lamps

To turn on the map lamps, press the control next to each lamp.

If equipped with a moon roof, the map lamps are located on the rearview mirror. Press the control next to the map lamp to illuminate the lamp.

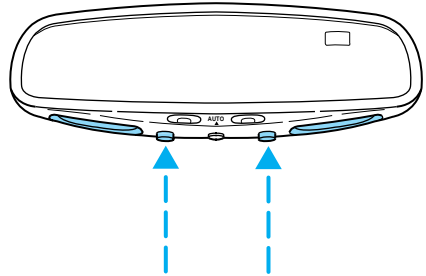



## Controls and features

### Rear courtesy/reading lamps

The courtesy lamp lights when:

- any door is opened.
- when the instrument panel dimmer switch is turned to the courtesy lamp position.
- if any of the keyless entry keypad controls are pressed and the ignition is OFF.

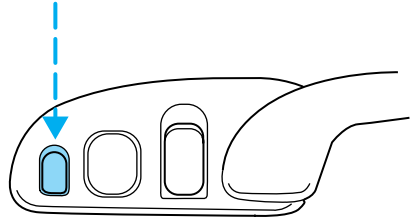

With the ignition key in the ACC or ON position, the reading lamp can be turned on by pressing the rocker control.

### LINCOLN RESCU SYSTEM (IF EQUIPPED)

Lincoln RESCU runs a self-test when you start your vehicle. During this test, the Lincoln RESCU warning light (located in the overhead console) will illuminate briefly. If a problem is detected during the self-check, the light will remain lit and the message “RESCU FAILURE” will be displayed on the vehicle’s message center for several seconds.

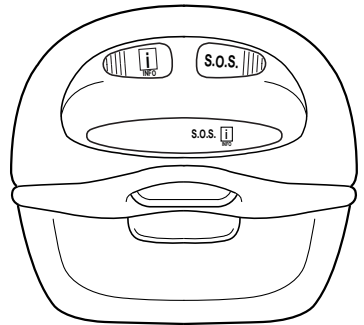

If the warning light fails to briefly illuminate when you start your vehicle, or if it remains lit, have your Lincoln RESCU System checked by an authorized dealer as soon as possible. Your system may be inoperative.



It is important that you understand the limitations of your Lincoln RESCU System prior to initiating an activation. See *Lincoln RESCU System Limitations* later in this chapter for details.

The RESCU system can be activated in three ways:

## Controls and features

1. By pressing the Information control.

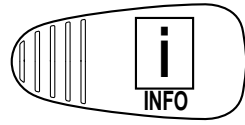

2. By pressing the Emergency (S.O.S) control.



3. The system will automatically activate if the vehicle's air bags have been deployed.

### Quick summary

- To utilize your vehicle's RESCU system, your cellular phone must be activated.
- Information or emergency assistance can be requested whenever your key is in the RUN/START position and for six minutes after the vehicle is turned off.
- An assistance request is initiated by pressing either the Information or Emergency control located in the overhead console.
- When a control is pressed, a warning lamp located in the overhead console will begin to flash and status messages are displayed on the vehicle's message center (messages can only be displayed when the key is in the RUN/START position).
- The vehicle's cellular phone automatically places a call to a 24 hour emergency response center.
- When contact is made, the vehicle sends an electronic data message to the response center's computer. This data message includes latitude and longitude coordinates obtained from the vehicle's positioning system.
- Once the data transmission is complete, the call is forwarded to a response center operator who confirms your location using a computerized map.
- The vehicle's cellular handset is locked-out, the phone is automatically placed in the "hands-free" mode and voice communication is established with the operator through the "hands-free" microphone.

## Controls and features

- Typically, voice communication with an operator is established within one minute after an assistance control is pressed.
- The operator verbally obtains details of your situation and, if necessary, ties your vehicle into a three-way phone call with the United States Auto Club or local 911 or other emergency services to dispatch the appropriate assistance to your location.
- Once the situation has been appropriately handled, the operator will terminate the call, the system warning light will stop flashing and the system will be reset. In most situations, only the response center can terminate an assistance request.

### General description

Lincoln's Remote Emergency Satellite Cellular Unit (RESCU) is designed to expedite roadside, emergency or information assistance to distressed motorists who are uncertain of their location and/or are uncertain of who to contact for assistance.

The Lincoln RESCU system utilizes Global Positioning System (GPS) technology and the nation's cellular phone network to track vehicle location and, at the touch of a control, put you in voice contact with the Lincoln Security Response Center.

Two controls in the overhead console will activate the system:

An Information icon is provided for customer information, such as points of interest in your current location, route assistance and other services as they become available.

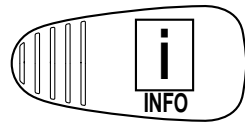

An Emergency icon for is for emergency assistance.

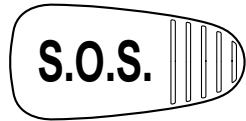

When you select a control, the vehicle's cellular phone will automatically place a data call to the response center's central computer. Once contact is made, an electronic data message will be transmitted. This data message will include:

- Type of alarm (Information, emergency or air bag activation)
- Vehicle Identification Number (VIN)
- Latitude and longitude coordinates

## Controls and features

- Last recorded speed and direction of the vehicle
- Time tag identifying when last position was taken
- Call-back phone number

After the transmission is complete, the call is forwarded to an operator who will verify the details of the request and confirm the vehicle's location using a computerized map.

### Information icon

The Information icon is provided for customer information, such as points of interest in your current location, rout assistance and other services as they become available.

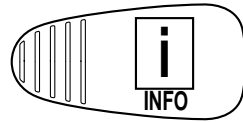

There may be charges incurred for certain services.

### Emergency (S.O.S) icon (emergency assistance)

The Emergency (S.O.S) control should be selected if emergency assistance is required. This feature should be used:



- if you have been involved in an accident.
- to report a crime or fire.
- when medical attention is required.
- to receive assistance in an emergency situation.

When this control is pressed, the Lincoln Security Response Center relays details of your situation and your location to the United States Auto Club (USAC) via three-way phone call. The response center/USAC will:

- dispatch the emergency help to your location.
- when appropriate, stay in direct phone contact with you until emergency help arrives.
- notify pre-designated family contacts or friends of the emergency situation, if requested, or if no response is received from the vehicle.

If you are certain of your location, a direct phone call to 911 or other emergency services may provide a faster response.

## Controls and features

### Activation and deactivation

When either of the two Lincoln RESCU controls are pressed, or the air bags are deployed (this will activate the system as an emergency automatically), a warning light, located in the overhead console, will begin to flash and status messages will be displayed on the vehicle's message center, confirming an assistance request has been made. The warning light will continue to flash throughout the activation.

The system can be activated whenever your ignition key is in the RUN/START position and for six minutes after your vehicle is turned off. Once a RESCU control has been pressed, do not attempt to cranks the engine as this may cancel the activation. In most situations, the assistance request can only be terminated and the system reset when a special tone is sent to the vehicle by the Lincoln Security Response Center. (See *Automatic redial* later in this chapter for exceptions.) Operation will continue even if the vehicle is turned off during an activation (although visual feedback via the message center will not be available in this situation).

### Cellular phone interface

The cellular phone must be connected to the vehicle and activated for the system to work. During an activation, Lincoln RESCU takes control of the vehicle's cellular phone. If the phone is in use, the call will be terminated and the Lincoln Security Response Center will automatically be dialed. The cellular handset becomes inoperative and all voice communication with the operator is accomplished via the cellular phone's "hands-free" microphone.

When an activation is terminated, your phone is left unlocked, in the ON state and may not return to its previous call restriction or system selection setting. It can be reprogrammed to your previous setting as desired.

Refer to your cellular phone user's manual for further information.

### Message center interface

During an activation, Lincoln RESCU communication with the vehicle's message center. Status message describing the sequence of the steps being executed are displayed, allowing you to visually follow the activation process. The following messages are typical of those displayed during an assistance request. They are as shown in the order in which they would appear:

## Controls and features

- INFORMATION REQUEST, EMERGENCY REQUEST or AIR BAG REQUEST
- CALL IN PROGRESS
- RINGING RESPONSE CENTER
- SENDING LOCATION DATA
- DATA RECEIVED
- WAITING FOR OPERATOR

Once an assistance request is made, it will typically take less than one minute until contact is made with an operator. During voice communication the following messages will alternately toggle on the display:

- CID XXXXXXXXXXXX
- LAT XXXXXXXXXXXX
- LON XXXXXXXXXXXX
- HDG XX

These messages respectively are the customer identification number, vehicle latitude, vehicle longitude and heading. Under special conditions, the operator may ask you to read the information being displayed on the message center.

If vehicle messages are being displayed on the message center (low washer fluid, low oil, door ajar, etc.), they must be cleared in order to view the Lincoln RESCU messages. To clear the vehicle messages, press the message center RESET control which is located to the right of the display. Continue pressing the control until all messages are cleared.

### Automatic redial

As described previously, when an assistance request is made, the vehicle's cellular phone automatically dials the Lincoln Security Response Center's central computer and attempts to send an electronic data message. Occasionally, it can be difficult for the computer to recognize the message if the cellular connection is weak or noisy. If the transmission of the message is unsuccessful, the data call will be terminated and the message "REDIAL IN PROGRESS" will be displayed on the message center. A second call will automatically be placed which bypasses the response center's computer and is forwarded directly to an operator.

## Controls and features

Similarly, if the cellular call is disconnected by the network prior to receipt of the termination tone, another call to the response center will also automatically be dialed. The message “REDIAL IN PROGRESS” will be displayed on the message center and voice communication with an operator will be restored.

During redial calls, full control of the cellular phone is returned to you. Pressing either PWR or END on the cellular handset will terminate the assistance request and reset the system.

### **Location data retransmit capability**

During an activation, the Lincoln Security Response Center operator has the capability to initiate a retransmission of the electronic data message. This may be necessary to ensure a more precise determination of vehicle location or to track a vehicle that is moving. To accomplish the retransmit, a special tone is sent to the vehicle by the response center. In this situation you will temporarily lose voice contact with the operator and the messages “SENDING LOCATION DATA” and “DATA RECEIVED” will be respectively displayed on the message center. After the data retransmission is complete, voice communication will be restored and the CID, LAT, LON and HDG message will again alternately toggle on the message center display.

### **Global positioning system**

Vehicle location is continuously updated via Global Positioning System (GPS) technology. GPS was developed by the U.S. Department of Defense for worldwide navigational and positioning purposes. It utilizes a constellation of 24 orbiting satellites located more than 20 000 km (12 428 miles) above the earth. At any given time, several of the 24 satellites should be visible to the vehicle's GPS receiver. Based on the time for signals emitted by these satellites to reach the receiver, an on-board computer will determine the vehicle's location, typically within 30 meters (100 feet). In addition to latitude and longitude, the system also determines heading and speed.

Vehicle positioning information is relayed to the Lincoln Security Response Center only during roadside or emergency requests. The response center will not be able to track your location while in an inactive state.

## Controls and features

### Lincoln RESCU system limitations

#### ***Inoperative if cellular phone inactive or inoperative***

Lincoln RESCU utilizes your vehicle's cellular phone and will not operate if cellular service has not been activated or if the phone is inoperative.

#### ***Inoperative if battery discharged or disconnected***

Lincoln RESCU is powered by the vehicle's battery and will not operate if the battery is discharged or disconnected.

#### ***Potentially inoperative if vehicle involved in accident***

If the vehicle is involved in an accident, some components can be damaged, rendering your RESCU System inoperative.

#### ***Positioning capability degraded if satellite signals obstructed***

Vehicle positioning is accomplished by receiving and interpreting signals transmitted by satellites. If the signals are obstructed positioning capability could be degraded or lost. This situation will be most prevalent in urban areas populated with tall buildings, tunnels, underpasses, parking garages, trees and similar structures could also adversely affect positioning performance. Under these conditions, the system will operate but the response center could have difficulty identifying your current location. (The last valid position obtained before the obstruction is retained, however, and will be sent.) The operator may depend on you to provide verbal information regarding vehicle location.

#### ***Positioning capability temporarily degraded after battery reconnect***

When your vehicle is started, the Lincoln RESCU GPS receiver begins the process of determining vehicle location. The receiver will search the sky and attempt to acquire signals from all visible satellites. A real-time clock and an almanac containing detailed information about satellite constellation are stored in the on-board computer's memory and are used to expedite the search. If the vehicle's battery is disconnected, the clock memory is erased and time and date are lost. Once the battery is reconnected, it could take approximately 15 minutes to reacquire the clock and for positioning capability to be restored. During this time, the system will operate but the response center will not be able to identify your location. In this situation, the operator will depend on you to provide verbal information regarding vehicle location.



## Controls and features

### ***Inoperative if cellular signal marginal or unavailable***

Since the Lincoln RESCU System utilizes the vehicle's cellular phone, it can only be operated in geographical areas with cellular coverage. Although approximately 90 percent of the U.S. population lives and works in cellular coverage areas, there are various rural or mountainous areas where coverage is marginal or does not exist. If an activation occurs in this situation, the messages "NO CELLULAR SIGNAL" and "WAITING TO ACQUIRE" will alternately be displayed on the message center. If after several attempts cellular service can not be acquired, the message "UNABLE TO PLACE CALL" will be displayed, the assistance request will be terminated and the phone will return to its normal operating mode.

### ***Inoperative if cellular system is busy***

In a particular area, the local cellular system can only handle a limited number of cellular calls at one time. Once volume has reached the maximum limit, additional callers are denied access. If an activation occurs in this situation, the messages "CELLULAR SYSTEM BUSY" and "PLEASE WAIT" will alternately be displayed on the message center. If after several attempts a cellular channel cannot be acquired, the message "UNABLE TO PLACE CALL" will be displayed, the assistance request will be terminated and the phone will return to its normal operating mode.

### ***Incompatible with cellular PIN feature***

Some cellular carriers offer custom phone numbers that are assigned a personal identification number (PIN). In this situation, the user is required to enter the PIN with any phone calls made over the network. The Lincoln RESCU System is not compatible with the PIN feature. At the time your phone is activated, ask your carrier to assign you a phone number that does not require an personal identification number. If you have difficulty obtaining a non-PIN number, contact you dealer or call the Ford Cellular System Clearinghouse at 1-800-367-3357 for assistance.

### ***Incompatible or performance limited with certain cellular providers features***

Some cellular carriers offer customers various optional features with their cellular services. Several of these features are not compatible or could potentially limit the performance of your Lincoln RESCU System. No outgoing calls, hotline and NPA restrictions are incompatible cellular

## Controls and features

features and must be avoided. Operation is possible with no incoming calls, call forwarding, busy/no answer transfer and call waiting, but these features could impact overall system performance. Because carriers are regularly making new features available to customers, this list may not be complete. Contact your dealer for assistance if you are unsure if a particular cellular feature is compatible with your Lincoln RESCU System.

### ***Potential limitations if activated outside home cellular region***

At the time you receive your vehicle (or shortly after), you will need to select a cellular carrier and activate your phone. If desired, carrier selection can be arranged through your dealer. This carrier is usually local to your region and will handle call processing and billing services for your cellular telephone. In order to use your phone when traveling outside your home cellular region, the services of the carriers local to the new area will be required. If your home carrier does not have an agreement with the new local carrier, your phone calls could be forwarded to an operator and you may be required to provide a credit card number before your call is processed. If an activation occurs in this situation, the initial call will be terminated and a second call which bypasses the response center's computer will be placed.

Unlike during the first call attempt, your cellular handset will not be locked during the second call, so you will have the option of terminating the assistance request at any time by pushing either PWR or END on the cellular phone. If the second call is not terminated, it will be forwarded to a local cellular carrier operator. In this situation, you can provide the operator with the number you are dialing (Lincoln Security Response Center at 1-800-334-1327) and your credit card number or ask to be connected to the local 911 or other emergency services.

### **Registration requirement**

You are required to register with the Lincoln Security Response Center shortly after receiving your vehicle. The registration process is simple and can be accomplished by calling the Lincoln Security Response Center at 1-800-334-1327. Alternatively, the registration process can be completed on-line during an acquaintance period activation. (See "Acquaintance activations" later in this section for details.) The information requested will aid in servicing you more efficiently during an assistance request.

## Controls and features

### Optional password selection/false activations

At the time of your registration, you will be given the option of establishing a user password. All aspects of your service will be identical regardless of your password decision except the way false emergency activations are handled. If established, the password will be requested by the operator to confirm an emergency activation was initiated in error. If no password or an incorrect password is given, the response center's operator will seemingly terminate the call but actually stays on the line and sends police to the last calculated vehicle location (this could be very useful in duress situations). It is very important that you remember your password to prevent false dispatches. Similarly, it is also important to provide the password to any other individuals who will be driving the vehicle or who may have need to activate the system.

If you decide not to establish a password, simply indicate to the operator that the emergency assistance request was initiated in error and the call will be terminated.

In either case, if an activation (roadside or emergency) occurs and the operator cannot establish voice communication, police assistance will be dispatched to the vehicle.

Information regarding changing or retrieving lost passwords can be obtained by contacting the Lincoln Security Response Center at 1-800-334-1327.

### Acquaintance activations

It is required that you initiate an acquaintance activation shortly after receiving your vehicle and having your phone activated. An acquaintance activation is initiated by pressing either the roadside or emergency control. When voice communication is established with the Lincoln Security Response Center, indicate that you are a new user and the operator will follow special acquaintance period support procedures which are intended to familiarize you with your Lincoln RESCU System. As described previously, the acquaintance call can also be used to complete the registration for new customers.

### Service charges

For four years, beginning with your vehicle's warranty period, you will be entitled to unlimited activations without facing service charges. (These activations should be made only when emergency or roadside assistance is required.) You will be responsible, however, for any charges imposed by your cellular phone carrier for the 1-800 phone call to the Lincoln

## Controls and features

Security Response Center. After your initial service period expires, you may be required to pay a monitoring service fee. Your dealer can provide you with specific information regarding post-initial service period fees.

### Relinquishing your vehicle

At the time you relinquish your vehicle, it is important that you contact the Lincoln Security Response Center at 1-800-223-1327 and cancel your security service. Personal information provided to the response center at the time of your registration will be removed from the vehicle's file.

### MOON ROOF (IF EQUIPPED)

To open the moon roof:

- Press and hold the control forward to raise the moon roof to the vent position (when the glass panel is closed).
- Press the control rearward to fully open the moon roof.

To close the moon roof:

- Press the control forward.
- To close from the vent position, press and hold the control rearward.

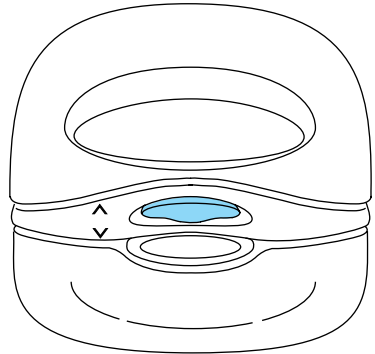

### ILLUMINATED VISOR MIRROR

To turn on the visor mirror lamps, lift the mirror cover.

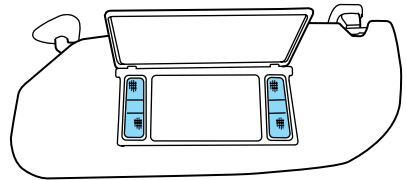

### HOMELINK® UNIVERSAL TRANSMITTER (IF EQUIPPED)

The HomeLink® Universal Transmitter, located underneath the driver's visor, provides a convenient way to replace up to three hand-held transmitters with a single built-in device. This feature will learn the radio frequency codes of most current transmitters to operate garage doors

## Controls and features

and gates, and can also control home or office lighting and security systems (with the available accessory package).



When programming your HomeLink® Universal Transmitter, you will be operating the garage door or gate. Be sure that people and objects are out to the way to prevent potential harm or damage.

Do not use the HomeLink® Universal Transmitter with any garage door opener that lacks safety stop and reverse features as required by U.S. federal safety standards (this includes any garage door opener model manufactured before April 1, 1982). A garage door which cannot detect an object, signaling the door to stop and reverse, does not meet current U.S. federal safety standards. For more information on this matter, call toll-free: 1-800-355-3515.

### Programming

1. Prepare for programming the HomeLink® Universal Transmitter by erasing all three of the factory default channels by holding down the two outside controls until the red light begins to flash (20-30 seconds). Release both controls.

2. Hold the end of your hand-held transmitter against the HomeLink® Universal Transmitter (located on your visor) while keeping the red light in view.

3. Using both hands, press the hand-held transmitter control and the desired channel control on the HomeLink® Universal Transmitter. Do not release the controls until step 4 has been completed.

4. Hold down both controls until the red light begins to flash slowly and then rapidly. Rapid flashing indicates successful programming of the new frequency signal.

5. Follow steps 2 through 4 to program the remaining two channels.

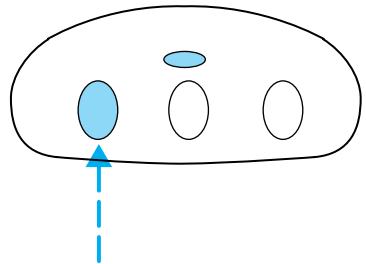
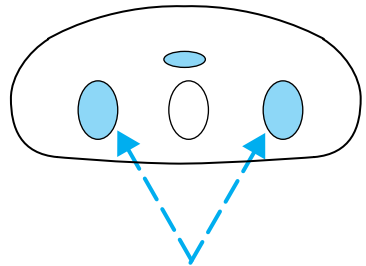

## Controls and features

If you do not successfully program the HomeLink® Universal Transmitter after repeated attempts, refer to *Training a rolling code* which follows or call toll-free customer assistance: 1-800-355-3515.

### Note to Canadian residents

During programming, your hand-held transmitter may automatically stop transmitting after two seconds which may not be long enough to program the HomeLink® Universal Transmitter.

If you are programming from one of these hand-held transmitters:

- continue to hold the control on the HomeLink® Universal Transmitter
- re-press the hand-held transmitter every two seconds

You may have to repeat this function several times while programming.

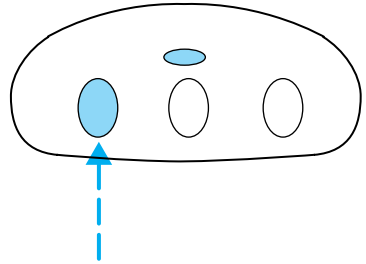

### Operating the HomeLink® Universal Transmitter

Once programmed, the HomeLink® Universal Transmitter can be used in place of hand-held transmitters. To operate, simply press the appropriate channel control on the transmitter (the red light will illuminate, indicating the signal is being transmitted).

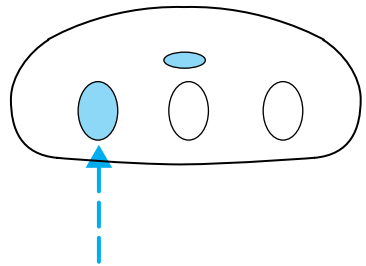

### Training a rolling code system

Rolling code systems (garage door openers which are “code protected”) may be determined by the following:

- The hand-held transmitter appears to program the HomeLink® Universal Transmitter but does not activate the garage door.
- The garage door opener was manufactured after 1995.

Follow these steps to train a garage door with the rolling code feature:

## Controls and features

1. Locate the training control on the garage door opener receiver. Refer to the garage door opener manual or call 1-800-355-3515 if there is difficulty locating the training control.
2. Press the training control on the garage door opener receiver until the training light (next to the control) begins to flash (1-2 seconds).
3. Press the programmed HomeLink® control in the vehicle until the training light on the garage door receiver turns solid (1-2 seconds). Release the HomeLink® control and repress to turn off the training light.
4. Press the HomeLink® control again. If the garage door activates, the HomeLink® Universal Transmitter has been trained to the receiver.

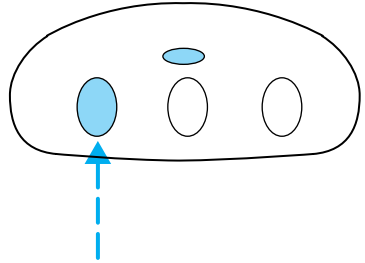

### Erasing channels

To erase all three programmed channels:

1. Hold down the two outside controls until the red light begins to flash.
2. Release both controls.

Channels cannot be erased individually, but can be reprogrammed. Refer to *Programming* for instructions.

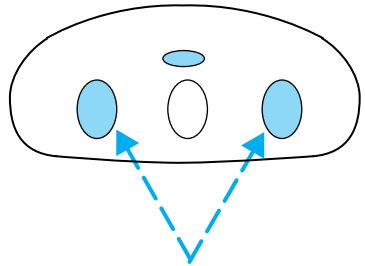

### ELECTRONIC COMPASS

The compass reading may be affected when you drive near large buildings, bridges, power lines and powerful broadcast antenna. Magnetic or metallic objects placed in, on or near the vehicle may also affect compass accuracy.

Usually, when something affects the compass readings, the compass will correct itself after a few days of operating your vehicle in normal conditions. If the compass still appears to be inaccurate, a manual

## Controls and features

calibration may be necessary. Refer to *Compass calibration adjustment*.

Most geographic areas (zones) have a magnetic north compass point that varies slightly from the northerly direction on maps. This variation is four degrees between adjacent zones and will become noticeable as the vehicle crosses multiple zones. A correct zone setting will eliminate this error. Refer to *Compass zone adjustment*.

### Compass zone adjustment

1. Determine which magnetic zone you are in for your geographic location by referring to the zone map.

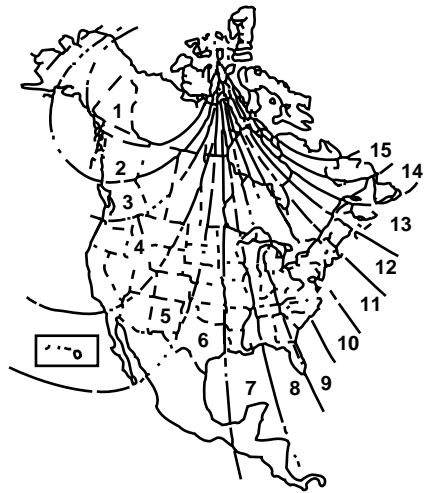

2. Locate the compass module mounted at the base of mirror.

3. Turn the ignition to the ON position.

4. Insert an appropriate diameter rod (paperclip) into the right switch access hole underneath the compass module and gently press for 1 to 2 seconds until ZONE and the current zone setting are displayed on the upper right corner of the mirror.

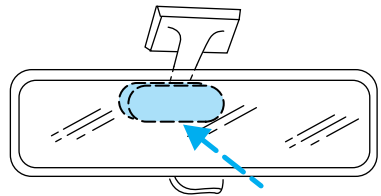



## Controls and features

5. Release the switch, then slowly press it down again. Press the switch repeatedly until the correct zone setting for your geographic location is displayed on the upper right corner of the mirror.
6. To exit the zone setting mode, release pressure from the switch for greater than two seconds.

### **Compass calibration adjustment**

Perform this adjustment in an open area free from steel structures and high voltage lines.

For optimum calibration, turn off all electrical accessories (heater/air conditioning, wipers, etc.) and make sure all vehicle doors are shut.

1. Start the vehicle.
2. Locate the compass module mounted on the base of mirror.
3. Insert an appropriate diameter rod (paperclip) into the left switch access hole underneath the compass module.
4. Gently press the switch for 1 to 2 seconds until CAL and a direction are displayed on the upper right corner of the mirror. (To exit CAL before performing a compass adjustment, turn the ignition to OFF.)
5. Release pressure from the switch.
6. Slowly drive the vehicle in a circle (less than 5 km/h [3 mph]) until the CAL indicator turns off. This will take up to five circles to complete calibration.
7. The compass is now calibrated.

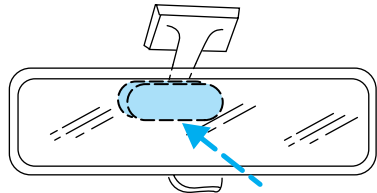

The compass display will remain on for approximately 40-45 minutes after the ignition key is removed. The battery saver will then shut off the display.

### **AUTOMATIC DIMMING INSIDE REAR VIEW MIRROR**

The electronic day/night mirror will change from the normal state to the non-glare state when bright lights (glare) reach the mirror. When the mirror detects bright light from front or behind, it will automatically adjust to minimize glare.

## Controls and features

Press the control to turn the mirror on or off. The mirror will automatically return to the normal state whenever the vehicle is placed in R (reverse)(when the mirror is on) to ensure a bright clear view when backing up.

Do not clean the housing or glass of any mirror with harsh abrasives, fuel or other petroleum-based cleaning products.

On vehicles equipped with a moonroof, the automatic rear view mirror has two map lamps. Refer to *Interior lights* for more information.

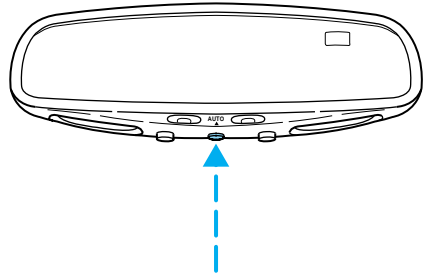

### POWER DOOR LOCKS

Press U to unlock all doors and L to lock all doors.

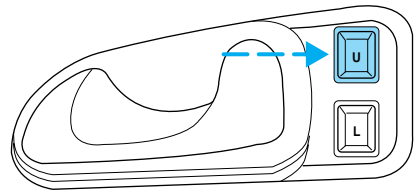

### Smart locks

With the key in the ignition, in any switch position, and either the driver's or passenger's door open, the doors cannot be locked using the front door lock switches.

While the key is in the ignition, the vehicle can be locked by manually pressing down the lock control or with remote entry transmitter.

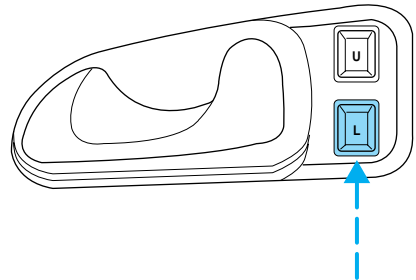

## Controls and features

### POWER WINDOWS

Press and hold the rocker switches to open and close windows.

- Press the top portion of the rocker switch to open.

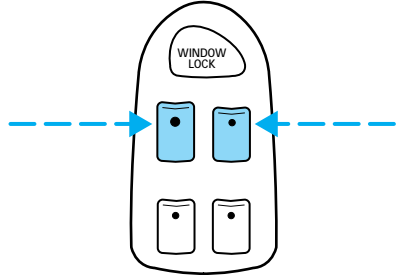

- Pull the top portion of the rocker switch to close.

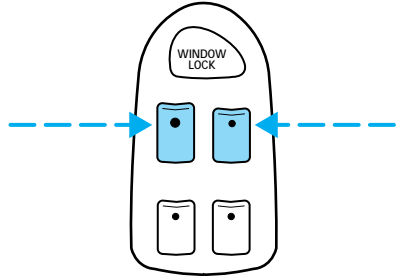

### Express down

To make the driver window open fully without holding the window control, press the driver window control completely down and release quickly. Depress again to stop window operation.

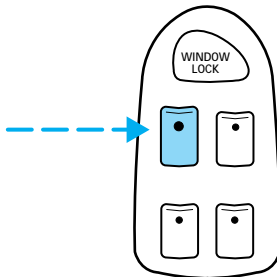

## Controls and features

### Window lock

The window lock feature allows only the driver to operate the power windows.

To lock out all the window controls except for the driver's press the right side of the control. Press the left side to restore the window controls.

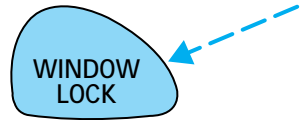

### Accessory delay

With accessory delay, the window switches may be used for up to ten minutes after the ignition switch is turned to the OFF position or until any door is opened.

### POWER SIDE VIEW MIRRORS

The ignition must be in ACC or ON position to adjust the power side view mirrors.

To adjust your mirrors:

1. Select L to adjust the left mirror or R to adjust the right mirror.

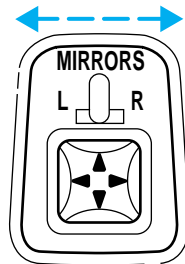

2. Move the control in the direction you wish to tilt the mirror.

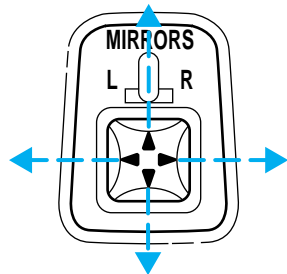

## Controls and features

3. Return to the center position to lock mirrors in place.

### Heated outside mirrors

Both mirrors are heated automatically to remove ice, mist and fog when the rear window defrost is activated.

Do not remove ice from the mirrors with a scraper or attempt to readjust the mirror glass if it is frozen in place. These actions could cause damage to the glass and mirrors.

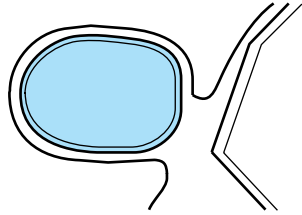

### CHILDPROOF DOOR LOCKS

When these locks are set, the rear doors cannot be opened from the inside. The rear doors can be opened from the outside when the doors are unlocked.

The childproof locks are located on rear edge of each rear door and must be set separately for each door. Setting the lock for one door will not automatically set the lock for both doors.

Move lock control up to engage the lock. Move control down to disengage childproof locks.

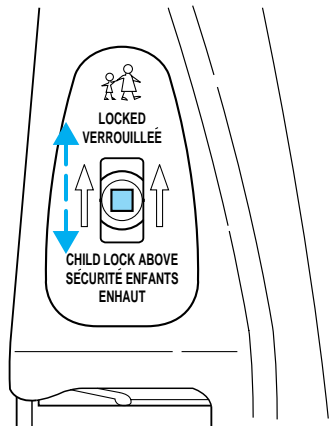

## Controls and features

### CENTER CONSOLE (IF EQUIPPED)

Your vehicle is equipped with a variety of console features. These include:

- utility compartment
- cupholders
- ashtray and lighter
- compact disc changer (if equipped)
- power point
- cellular phone (if equipped)

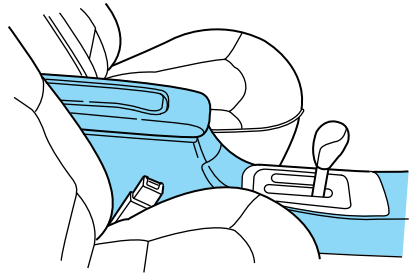

Use only soft cups in the cupholder. Hard objects can injure you in a collision.

### Compact disc changer (if equipped)

The compact disc changer is located inside the front center console. For information on the compact disc changer, refer to the “Audio Guide”.

### Mini console (if equipped)

The mini console is available in the six passenger vehicle only, and consists of the:

- beverage holder
- digital audio compact disc player (if equipped)
- ash receptacle
- cigar lighter knob and element

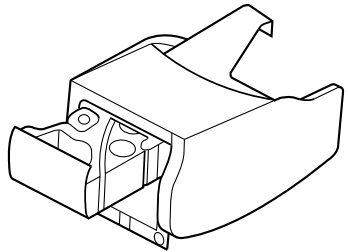

Use only soft cups in the cupholder. Hard objects can injure you in a collision.

## Controls and features

### POSITIVE RETENTION FLOOR MAT

Position the floor mat so that the eyelet is over the pointed end of the retention post and rotate forward to lock in. Make sure that the mat does not interfere with the operation of the accelerator or the brake pedal. To remove the floor mat, reverse the installation procedure.

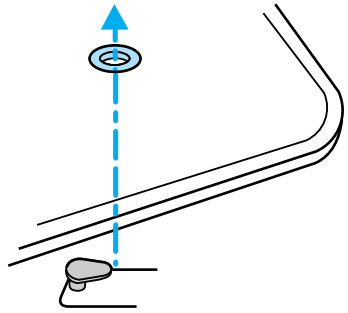

### PERIMETER ALARM SYSTEM (IF EQUIPPED)

#### Arming the system

When armed, this system will help protect your vehicle from unauthorized entry. When unauthorized entry occurs, the system will flash the headlamps and/or parking lamps and the theft indicator lamp and will chirp the horn.

The system is ready to arm whenever the ignition is turned OFF. Any of the following actions will prearm the alarm system:

- Locking the doors with the remote transmitter (doors opened or closed). The horn will chirp to confirm that the control was pressed. The horn chirp feature can be turned on/off by using the feature menu in the message center.
- Pressing 7/8 and 9/0 on the keyless entry pad at the same time to lock the doors (doors opened or closed).
- Opening a door and pressing the power door lock control to lock the doors.

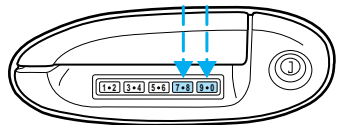
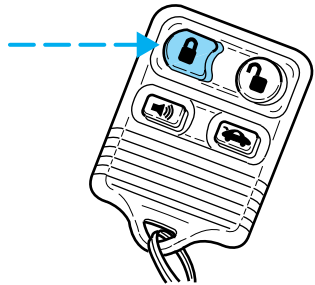

## Controls and features

If a door is open, the system is prearmed and is waiting for the door to close. The anti-theft indicator on the instrument panel will be lit continuously when the system is prearmed.

Once the doors are closed, the system will arm in 30 seconds.

### Disarming the system

You can disarm the system by any of the following actions:

- Unlock the doors by using your remote entry transmitter.
- Unlock the doors by using your keyless entry keypad.
- Unlock the doors with a key. Turn the key full travel (toward the front of the vehicle) to make sure the alarm disarms.
- Turn ignition to ACC or ON.

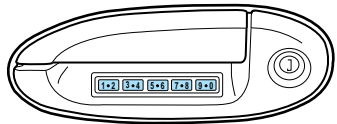
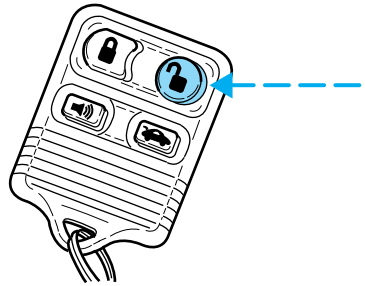

### SecuriLock™ anti-theft system

The SecuriLock™ anti-theft system provides an advanced level of vehicle theft protection. Your vehicle's engine can only be started with the two special SecuriLock™ electronically coded keys provided with your vehicle. Each time you start your vehicle, the SecuriLock™ key is read by the SecuriLock™ anti-theft system. If the SecuriLock™ key identification code matches the code stored in the SecuriLock™ anti-theft system, the vehicle's engine is allowed to start. If the SecuriLock™ key identification code does not match the code stored in the system or if a SecuriLock™ key is not detected (vehicle theft situation), the vehicle's engine will not operate.

Spare SecuriLock™ keys can be purchased from your dealership and programmed to your SecuriLock™ anti-theft system. Refer to *Programming spare SecuriLock™ keys* for more information.



## Controls and features

If one or both of your SecuriLock<sup>™</sup> keys are lost or stolen and you want to ensure the lost or stolen key will not operate your vehicle, bring your vehicle and all available SecuriLock<sup>™</sup> keys to your dealership for reinitialization.

### REMOTE ENTRY SYSTEM

The remote entry system allows you to lock or unlock all vehicle doors without a key.

The remote entry features only operate with the ignition in the OFF position.

#### Unlocking the doors

Press this control to unlock the driver door. The interior lamps will illuminate.

Press the control a second time within five seconds to unlock all doors.

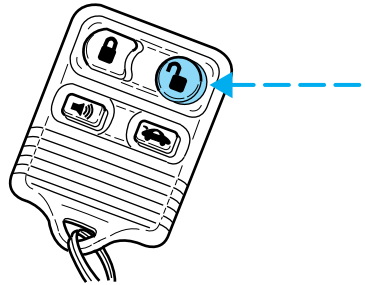

#### Locking the doors

Press this control to lock all doors.

The horn will chirp to confirm that the control was pressed. The horn chirp feature can be turned on/off by using the feature menu in the message center.

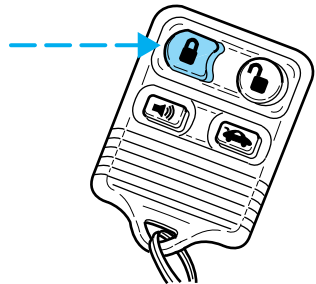

This process will arm your anti-theft system (if equipped). For more information on arming the anti-theft system, refer to *Perimeter anti-theft system* in this chapter.

## Controls and features

### Opening the trunk

Press the control once to open the trunk.

Be certain the trunk is closed before driving your vehicle. The trunk may appear closed, but it may not be latched. Failure to do so may cause objects to fall out of the trunk or block rear view vision.

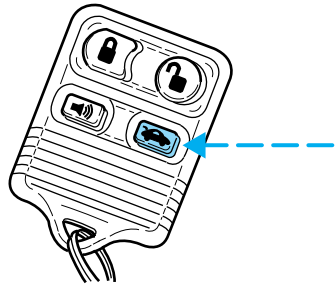

### Sounding a panic alarm

Press this control to activate the alarm.

To deactivate the alarm, press the control again or turn the ignition to ACC or ON.

This device complies with part 15 of the FCC rules and with RS-210 of Industry Canada. Operation is subject to the following two conditions: (1) This device may not cause harmful interference, and (2) This device must accept any interference received, including interference that may cause undesired operation.

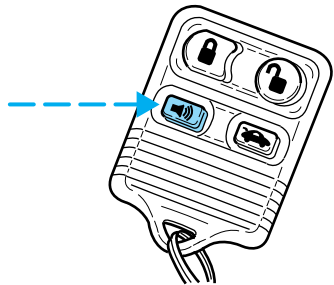

**Changes or modifications not expressly approved by the party responsible for compliance could void the user's authority to operate the equipment.**

### Replacing the batteries

The transmitter is powered by one coin type three-volt lithium battery CR2032 or equivalent. Typical operating range will allow you to be up to 10 meters (33 feet) away from your vehicle. A decrease in operating range can be caused by:

- battery weakness due to time and use
- weather conditions
- nearby radio towers

## Controls and features

- structures around the vehicle
- other vehicles parked next to the vehicle

To replace the battery:

1. Twist a thin coin between the two halves of the transmitter near the key ring. **DO NOT TAKE THE FRONT PART OF THE TRANSMITTER APART.**
2. Place the positive (+) side of new battery in the same orientation. Refer to the diagram inside the transmitter unit.
3. Snap the two halves back together.

### Replacing lost transmitters

Take all your vehicle's transmitters to your dealer for reprogramming if:

- a transmitter is lost or
- you want to purchase additional transmitters (up to four may be programmed).

To reprogram the transmitters:

1. enter the 5 digit factory keycode and within 5 seconds press the 1/2 button.
2. after the doors lock/unlock, press any button on all transmitters (up to four).
3. when completed, press the 7/8 and 9/0 buttons on the keypad at the same time.

All transmitters must be reprogrammed at the same time.

### Illuminated entry

The interior lamps illuminate when the remote entry system is used to unlock the door(s) or sound the personal alarm.

The system automatically turns off after 25 seconds or when the ignition is turned to the START or ACC position. The dome lamp switch (if equipped) must **not** be set to the OFF position for the illuminated entry system to operate.

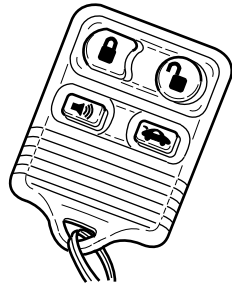

## Controls and features

The inside lights will not turn off if:

- they have been turned on with the dimmer control or
- any door is open.

The battery saver will shut off the interior lamps 40 minutes after the ignition has been turned to the OFF position.

### KEYLESS ENTRY SYSTEM

With the keyless entry keypad, you can:

- lock or unlock the vehicle doors without using the key.
- arm and disarm the perimeter alarm system (if equipped).
- reprogram remote entry transmitters.

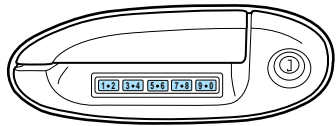

See also *Remote entry system* and *Perimeter alarm system* in this chapter for more information.

Your vehicle has a factory-set 5 digit code that operates the keyless entry system. You can also program your own 5 digit personal entry code.

The factory-set code is located:

- on the owner's wallet card in the glove compartment
- taped to the computer module
- in the interior of the trunk

When pressing the controls on the keyless entry keypad, press the middle of the buttons to ensure a good activation.

### Programming your own entry code

1. Enter the factory-set code (keypad will illuminate when pressed).
2. Press the 1/2 control within five seconds of step 1.
3. Enter your personal 5 digit code. Enter each digit within five seconds of the previous one.
4. Enter a sixth digit to indicate which personality feature should be recalled by the personal code.
  - 1/2 recalls personality 1

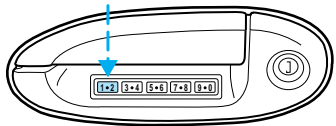

## Controls and features

- 3/4 recalls personality 2
- 9/0 does not recall a personality

All of the vehicle doors will lock and unlock to confirm programming of the new code. Each personality driver profile (personality 1 or personality 2) can be associated with only one personal code. The factory-set code cannot be associated with a personality profile.

Do not set a code that includes five of the same number or presents them in sequential order. Thieves can easily figure out these types of codes.

You can program up to three personal codes to unlock your vehicle. These codes do not replace the permanent code that the dealership gave you.

### **Erasing personal code**

To erase all of the personal entry codes programmed to a vehicle:

1. Enter the factory-set code.
2. Press 1/2 within 5 seconds of step 1.
3. Press and hold 1/2 for two seconds. All of the vehicle doors will lock and then unlock to confirm erasure.

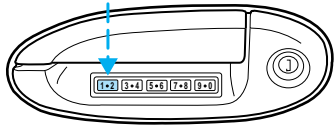

### **Unlocking the doors and releasing the trunk with the keyless entry system**

To unlock the driver door, enter either the factory-set code or personal code (each digit pressed within 5 seconds of prior digit). The interior lamps will illuminate.

To unlock all doors, enter the factory-set code or personal code (driver door unlocks) and press 3/4 within 5 seconds.

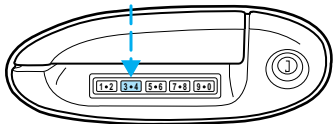

To release the trunk, enter the factory-set code or personal code (driver door unlocks) and press 5/6 within 5 seconds.

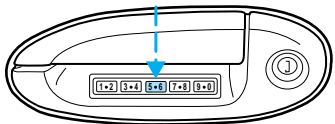

## Controls and features

After the factory-set code or personal code has been entered, you can unlock all doors (press 3/4) and release the trunk (press 5/6) as long as the controls are pressed within 5 seconds of each other.

### **Locking doors with the keyless entry system**

It is not necessary to enter the factory-set code prior to locking all doors. To lock the doors:

1. Press 7/8 and 9/0 at the same time.

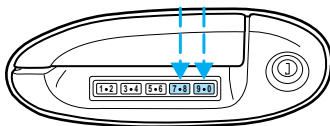

### **Autolock**

The autolock feature will lock all of the doors when:

- all vehicle doors are fully closed
- the ignition key is turned to the ON position
- the vehicle is in a forward gear and
- you exceed 5 km/h (3 mph).

The autolock feature repeats when:

- the ignition key remains in the ON position
- a door is opened and then closed
- the vehicle is in a forward gear, and
- you exceed 5 km/h (3 mph).

The autolock feature can be turned on/off by using the feature menu in the message center. Refer to *Electronic message center* for more information.

# Seating and safety restraints

## SEATING

### Head restraints

Push or pull the head rests to the desired position.

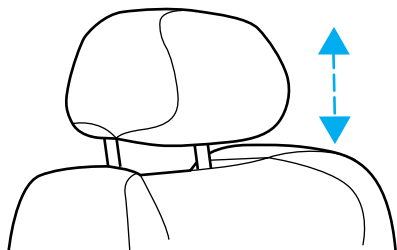

### Adjusting the power front seats – door mounted controls

The controls for the power seats are located on the inside of each front door.



Never adjust the driver's seat or seatback when the vehicle is moving.



Do not pile cargo higher than the seatbacks to avoid injuring people in a collision or sudden stop.



Always drive and ride with your seatback upright and the lap belt snug and low across the hips.

Press the control to recline the seatback forward or backward (if equipped).

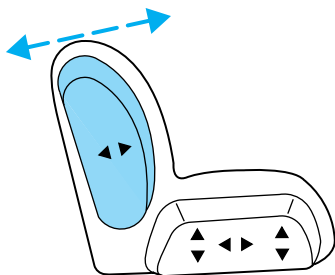

## Seating and safety restraints

Press to move the seat forward or backward.

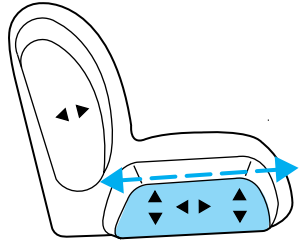

Press to move the front portion of the seat cushion up or down.

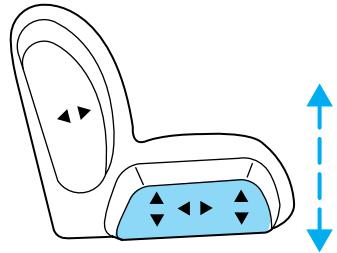

Press to move the rear portion of the seat cushion up or down.

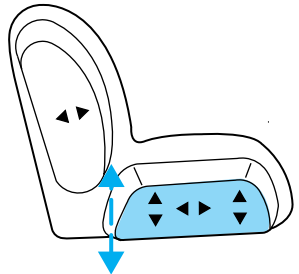



## Seating and safety restraints

### Heated seats (if equipped)

To operate the heated seats:

- Slide the control to BACK to heat the seatback only.
- Slide the control to BOTH to heat the seatback and the seat cushion.

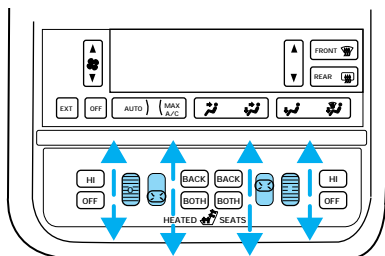

- Rotate the thumbwheel to select the desired heat (from 0 (OFF) to 5 (HI)). Allow five minutes for the heat level to stabilize.

If the heated seat switch is not turned OFF, the seat will heat up to the selected temperature level each time the vehicle is started.

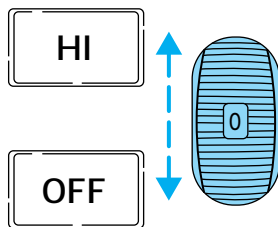

### Using the power lumbar support

The power lumbar control is located on the outboard side of the seat.

Press one side of the control to adjust firmness.

Press the other side of the control to adjust softness.

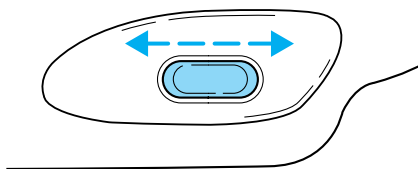

## SAFETY RESTRAINTS

### Safety restraints precautions



Always drive and ride with your seatback upright and the lap belt snug and low across the hips.



To prevent the risk of injury, make sure children sit where they can be properly restrained.

## Seating and safety restraints



Never let a passenger hold a child on his or her lap while the vehicle is moving. The passenger cannot protect the child from injury in a collision.



All occupants of the vehicle, including the driver, should always wear their safety belts.



It is extremely dangerous to ride in a cargo area, inside or outside of a vehicle. In a collision, people riding in these areas are more likely to be seriously injured or killed. Do not allow people to ride in any area of your vehicle that is not equipped with seats and safety belts. Be sure everyone in your vehicle is in a seat and using a safety belt properly.



Each seating position in your vehicle has a specific safety belt assembly which is made up of one buckle and one tongue that are designed to be used as a pair. 1) Use the shoulder belt on the outside shoulder only. Never wear the shoulder belt under the arm. 2) Never swing it around your neck over the inside shoulder. 3) Never use a single belt for more than one person.

### Combination lap and shoulder belts

1. To fasten, insert the tongue into the slot in the buckle.

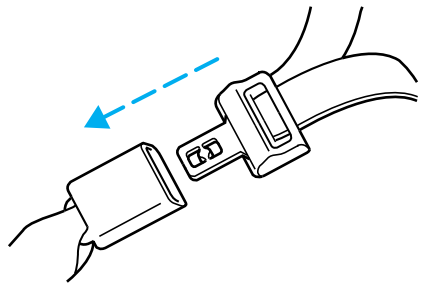

## Seating and safety restraints

2. To unfasten, push the red release button and remove the tongue from the buckle.

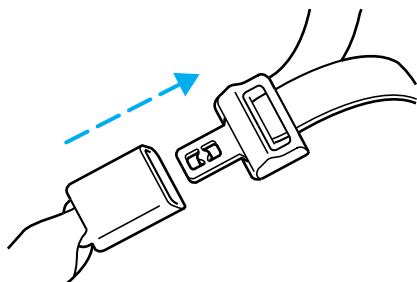

The front and rear outboard safety restraints in the vehicle are combination lap and shoulder belts. The front and rear seat passenger outboard safety belts have two types of locking modes described below:

### Vehicle sensitive mode

The vehicle sensitive mode is the normal retractor mode, allowing free shoulder belt length adjustment to your movements and locking in response to vehicle movement. For example, if the driver brakes suddenly or turns a corner sharply, or the vehicle receives an impact of 8 km/h (5 mph) or more, the combination safety belts will lock to help reduce forward movement of the driver and passengers.

### Automatic locking mode

In this mode, the shoulder belt is automatically pre-locked. The belt will still retract to remove any slack in the shoulder belt.

The automatic locking mode is not available on the driver safety belt.

### When to use the automatic locking mode

- When a tight lap/shoulder fit is desired.
- **Anytime** a child safety seat is installed in the vehicle. Refer to *Safety Restraints for Children* or *Safety Seats for Children* later in this chapter.

## Seating and safety restraints

### ***How to use the automatic locking mode***

- Buckle the combination lap and shoulder belt.

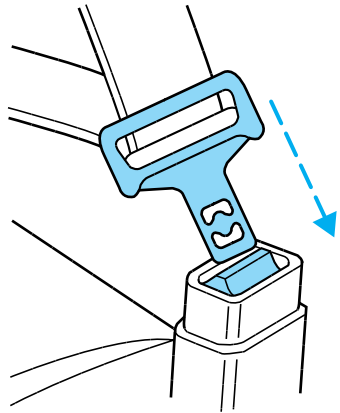

- Grasp the shoulder portion and pull downward until the entire belt is extracted.



- Allow the belt to retract. As the belt retracts, you will hear a clicking sound. This indicates the safety belt is now in the automatic locking mode.

### ***How to disengage the automatic locking mode***

Disconnect the combination lap/shoulder belt and allow it to retract completely to disengage the automatic locking mode and activate the vehicle sensitive (emergency) locking mode.

## Seating and safety restraints

### Front safety belt height adjustment

Your vehicle has safety belt height adjustments for the driver and front passenger. Adjust the height of the shoulder belt so the belt rests across the middle of your shoulder.

To lower the shoulder belt height, push the button and slide the height control down. To raise the height of the shoulder belt, slide the height adjuster up. Pull down on the height adjustment assembly to make sure it is locked in place.

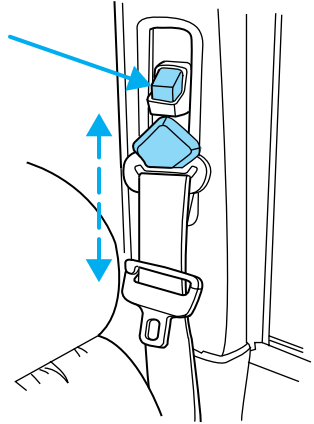

Position the shoulder belt height adjuster so that the belt rests across the middle of your shoulder. Failure to adjust the safety belt properly could reduce the effectiveness of the safety belt and increase the risk of injury in a collision.

### Lap belts

#### *Adjusting the lap belt*

The lap belt does not adjust automatically. Adjust to fit snugly and as low as possible around your hips. Do not wear the lap belt around your waist.

## Seating and safety restraints

Insert the tongue into the correct buckle. To lengthen the belt, turn the tongue at a right angle to the belt and pull across your lap until it reaches the buckle. To tighten the belt, pull the loose end of the belt through the tongue until it fits snugly across the hips.

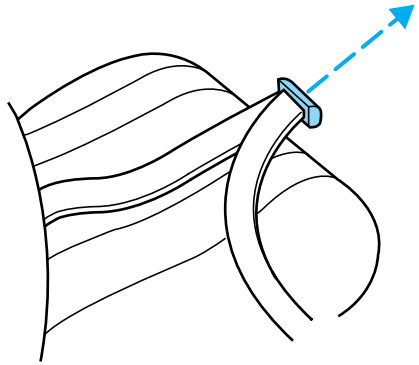

Shorten and fasten the belt when not in use.

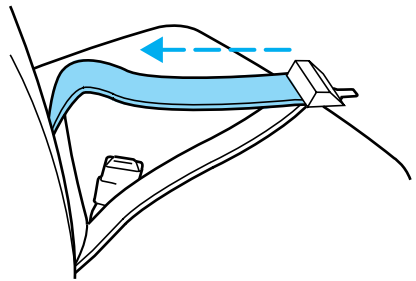

### Safety belt extension assembly

If the safety belt assembly is too short, even when fully extended, 20 cm (8 inches) can be added to the safety belt assembly by adding a safety belt extension assembly (part number 611C22). Safety belt extension assemblies can be obtained from your dealer at no cost.

Use only extensions manufactured by the same supplier as the safety belt. Manufacturer identification is located at the end of the webbing on the label. Also, use the safety belt extension only if the safety belt is too short for you when fully extended. Do not use extensions to change the fit of the shoulder belt across the torso.

### Safety belt warning light and indicator chime

The seat belt warning light illuminates in the instrument cluster and a chime sounds to remind the occupants to fasten their safety belts.

## Seating and safety restraints

### Conditions of operation

If...	Then...
The driver's safety belt is not buckled before the ignition switch is turned to the ON position...	The safety belt warning light illuminates for one to two minutes and the warning chime sounds for four to eight seconds.
The driver's safety belt is buckled while the indicator light is illuminated and the warning chime is sounding...	The safety belt warning light and warning chime turn off.
The driver's safety belt is buckled before the ignition switch is turned to the ON position...	The safety belt warning light and indicator chime remain off.

### Safety belt maintenance

Check the safety belt systems periodically to make sure they work properly and are not damaged. Check the safety belts to make sure there are no nicks, wears or cuts. All safety belt assemblies, including retractors, buckles, front seat belt buckle assemblies (slide bar) (if equipped), shoulder belt height adjusters (if equipped), child safety seat tether bracket assemblies (if equipped), and attaching hardware, should be inspected after a collision. Ford recommends that all safety belt assemblies used in vehicles involved in a collision be replaced. However, if the collision was minor and a qualified technician finds that the belts do not show damage and continue to operate properly, they do not need to be replaced. Safety belt assemblies not in use during a collision should also be inspected and replaced if either damage or improper operation is noted.



Failure to replace the safety belt assembly under the above conditions could result in severe personal injuries in the event of a collision.

Refer to *Cleaning and maintaining the safety belts* in the *Maintenance and care* section.

# Seating and safety restraints

## AIR BAG SUPPLEMENTAL RESTRAINT SYSTEM (SRS)

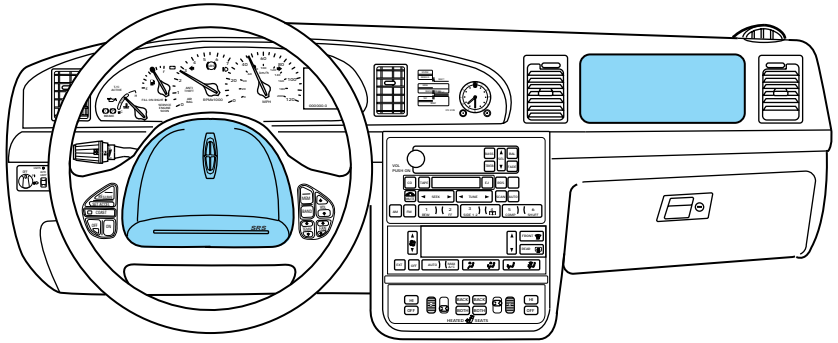

### Important supplemental restraint system (SRS) precautions

The supplemental restraint system is designed to:

- work with the safety belt to protect the driver and right front passenger.
- reduce certain upper body injuries.

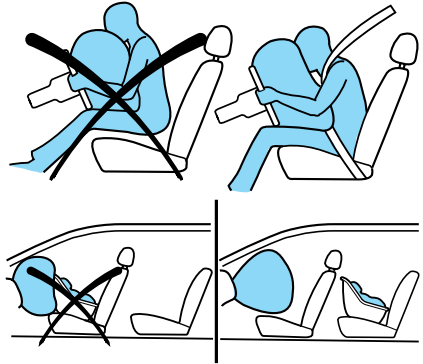

Failure to follow these instructions will affect the performance of the safety belts and increase the risk of personal injury.



The right front passenger air bag is not designed to restrain occupants in the center front seating position.



All occupants of the vehicle including the driver should always wear their safety belts even when air bag SRS is provided.



## Seating and safety restraints



Do not place objects or mount equipment on or near the air bag cover on the steering wheel or in front seat areas that may come into contact with a deploying air bag. Failure to follow this instruction may increase the risk of personal injury in the event of a collision.



Do not attempt to service, repair, or modify the Air Bag Supplemental Restraint System or its fuses. See your Ford or Lincoln-Mercury dealer.

### Children and air bags

For additional important safety information, read all information on safety restraints in this guide.

Children should always wear their safety belts. Failure to follow these instructions may increase the risk of injury in a collision.



Air bag can kill or injure a child in a child seat. If you must use a forward-facing child seat in the front seat, move seat all the way back.

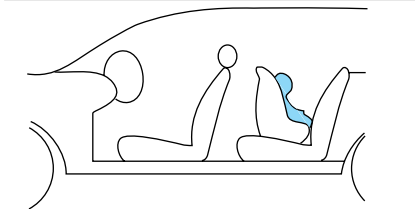
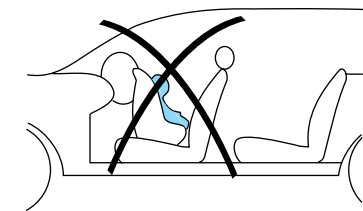

### How does the air bag supplemental restraint system work?

The SRS is designed to activate when the vehicle sustains sufficient longitudinal deceleration.

The fact that the air bags did not inflate in a collision does not mean that something is wrong with the system. Rather, it means the forces were not of the type sufficient to cause activation.

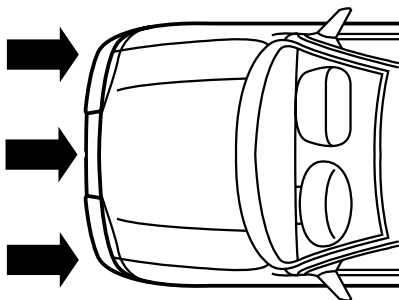

## Seating and safety restraints

The air bags inflate and deflate rapidly upon activation.

After air bag deployment, it is normal to notice a smoke-like, powdery residue or smell the burnt propellant. This may consist of cornstarch, talcum powder (to lubricate the bag) or sodium compounds (e.g., baking soda) that result from the combustion process that inflates the air bag. Small amounts of sodium hydroxide may be present which may irritate the skin and eyes, but none of the residue is toxic.



Several air bag system components get hot after inflation. Do not touch them after inflation.



If the air bag is inflated, **the air bag will not function again and must be replaced immediately**. If the air bag is not replaced, the unrepaired area will increase the risk of injury in a collision.

The SRS consists of:

- driver and passenger air bag modules (which include the inflators and air bags),
- one or more impact and safing sensors,
- a readiness light and tone
- and the electrical wiring which connects the components.

The diagnostic module monitors its own internal circuits and the supplemental air bag electrical system warning (including the impact sensors), the system wiring, the air bag system readiness light, the air bag back up power and the air bag ignitors.

### Determining if the system is operational

The SRS uses a readiness light in the instrument cluster or a tone to indicate the condition of the system. Refer to the *Air bag readiness*

## Seating and safety restraints

section in the *Instrumentation* chapter. Routine maintenance of the air bag is not required.

A difficulty with the system is indicated by one or more of the following:

- The readiness light will either flash or stay lit.
- The readiness light will not illuminate immediately after ignition is turned on.
- A series of five beeps will be heard. The tone pattern will repeat periodically until the problem and light are repaired.

**AIR  
BAG**

If any of these things happen, even intermittently, have the SRS serviced at your dealership or by a qualified technician immediately. Unless serviced, the system may not function properly in the event of a collision.

### Disposal of air bags and air bag equipped vehicles

For disposal of air bags or air bag equipped vehicles, see your local dealership or qualified technician. Air bags **MUST BE** disposed of by qualified personnel.

## SAFETY RESTRAINTS FOR CHILDREN

### Important child restraint precautions

You are required by law to use safety restraints for children in the U.S. and Canada. If small children ride in your vehicle (generally children who are four years old or younger and who weigh 18 kg [40 lbs] or less), you must put them in safety seats made especially for children. Check your local and state or provincial laws for specific requirements regarding the safety of children in your vehicle.



Never let a passenger hold a child on his or her lap while the vehicle is moving. The passenger cannot protect the child from injury in a collision.

Always follow the instructions and warnings that come with any infant or child restraint you might use.

When possible, place children in the rear seat of your vehicle. Accident statistics suggest that children are safer when properly restrained in the rear seating positions than in the front seating position.

## Seating and safety restraints

### Children and safety belts

Children who are too large for child safety seats (as specified by your child safety seat manufacturer) should always wear safety belts.

Follow all the important safety restraint and air bag precautions that apply to adult passengers in your vehicle.

If the shoulder belt portion of a combination lap and shoulder belt can be positioned so it does not cross or rest in front of the child's face or neck, the child should wear the lap and shoulder belt. Moving the child closer to the center of the vehicle may help provide a good shoulder belt fit.

If the shoulder belt cannot be properly positioned:

- move the child to one of the seats with a lap belt only (if equipped) or
- if the child is the proper size, restrain the child in a safety seat.



Do not leave children, unreliable adults, or pets unattended in your vehicle.

To improve the fit of lap and shoulder belts on children who have outgrown child safety seats, Ford recommends use of a belt-positioning booster seat that is labelled as conforming to all Federal motor vehicle safety standards. Belt-positioning booster seats raise the child and provide a shorter, firmer seating cushion that encourages safer seating posture and better fit of lap and shoulder belts on the child.

A belt-positioning booster should be used if the shoulder belt rests in front of the child's face or neck, or if the lap belt does not fit snugly on both thighs, or if the thighs are too short to let the child sit all the way back on the seat cushion when the lower legs hang over the edge of the seat cushion. You may wish to discuss the special needs of your child with your pediatrician.

### SAFETY SEATS FOR CHILDREN

#### Child and infant or child safety seats

Use a safety seat that is recommended for the size and weight of the child. Carefully follow all of the manufacturer's instructions with the safety seat you put in your vehicle. If you do not install and use the safety seat properly, the child may be injured in a sudden stop or collision.

## Seating and safety restraints

When installing a child safety seat:

- Use the correct safety belt buckle for that seating position.
- Make sure the tongue is securely fastened in the buckle.
- Keep the buckle release button pointing up and away from the safety seat, with the tongue between the child seat and the release button, to prevent accidental unbuckling.
- Place seat back in upright position.
- Put the safety belt in the automatic locking mode. Refer to *Automatic locking mode*.

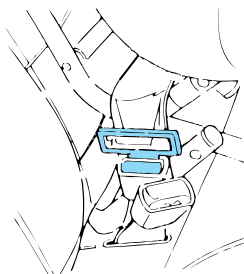

Ford recommends the use of a child safety seat having a top tether strap. Install the child safety seat in a seating position which is capable of providing a tether anchorage. For more information on top tether straps, refer to *Attaching safety seats with tether straps*.



Carefully follow all of the manufacturer's instructions included with the safety seat you put in your vehicle. If you do not install and use the safety seat properly, the child may be injured in a sudden stop or collision.

### Installing child safety seats in combination lap and shoulder belt seating positions

1. Position the child safety seat in a seat with a combination lap and shoulder belt.

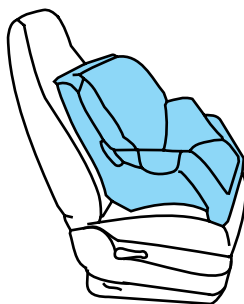

## Seating and safety restraints



Air bag can kill or injure a child in a child seat. If you must use a forward-facing child seat in the front seat, move seat all the way back.

2. Pull down on the shoulder belt and then grasp the shoulder belt and lap belt together.

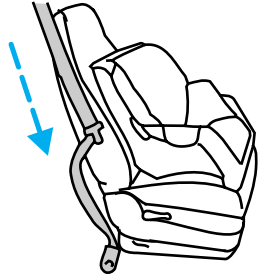

3. While holding the shoulder and lap belt portions together, route the tongue through the child seat according to the child seat manufacturer's instructions. Be sure the belt webbing is not twisted.

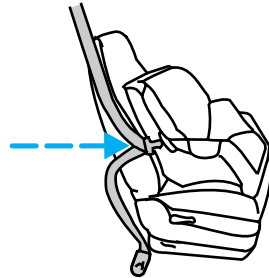

4. Insert the belt tongue into the proper buckle for that seating position until you hear and feel the latch engage. Make sure the tongue is latched securely by pulling on it.

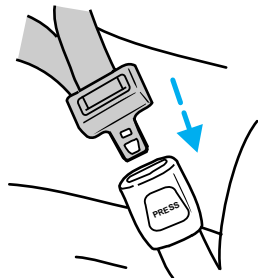

## Seating and safety restraints

5. To put the retractor in the automatic locking mode, grasp the shoulder portion of the belt and pull downward until all of the belt is extracted and a click is heard.

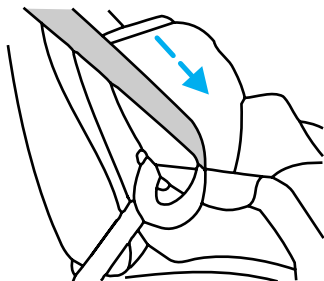

6. Allow the belt to retract. The belt will click as it retracts to indicate it is in the automatic locking mode.

7. Pull the lap belt portion across the child seat toward the buckle and pull up on the shoulder belt while pushing down with your knee on the child seat.

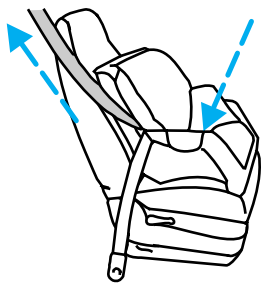

8. Allow the safety belt to retract to remove any slack in the belt.

9. Before placing the child in the seat, forcibly tilt the seat forward and back to make sure the seat is securely held in place.

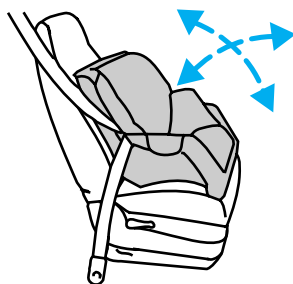

10. Try to pull the belt out of the retractor to make sure the retractor is in the automatic locking mode (you should not be able to pull more belt out). If the retractor is not locked, unbuckle the belt and repeat steps two through nine.

Check to make sure the child seat is properly secured before each use.

## Seating and safety restraints

### Installing a child safety seat in the center seating position with adjustable lap belt

1. Lengthen the lap belt. To lengthen the belt, hold the tongue so that its bottom is perpendicular to the direction of webbing while sliding the tongue up the webbing.
2. Place the child safety seat in the center seating position.
3. Route the tongue and webbing through the child seat according to the child seat manufacturer's instructions.
4. Insert the belt tongue into the proper buckle for the center seating position until you hear a snap and feel it latch. Make sure the tongue is securely fastened to the buckle by pulling on tongue.
5. Push down on the child seat while pulling on the loose end of the lap belt webbing to tighten the belt.
6. Before placing the child into the child seat, forcibly tilt the child seat from side to side and in forward direction to make sure that the seat is held securely in place. If the child seat moves excessively, repeat steps 5 through 6, or properly install the child seat in a different position.

### Attaching safety seats with tether straps

Some manufacturers make safety seats that include a tether strap that goes over the back of the vehicle seat and attaches to an anchoring point. Other manufacturers offer the tether strap as an accessory. Contact the manufacturer of your child safety seat for information about ordering a tether strap.

### Tether anchorage hardware

All vehicles include a tether anchor installed at the rear center seating position for use with child safety seats. Attachment holes (at each rear outboard seating position) have been provided in your vehicle to attach anchor hardware, if required. Additional kit can be obtained and installed at no charge from any Ford or Lincoln-Mercury dealer.

The tether strap anchorage bracket for the rear center seating position was factory installed and is located directly beneath the rear window

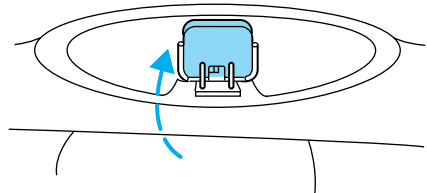



## Seating and safety restraints

trim panel, which is behind the rear seat back. To use this anchorage, do the following:

1. Open the hinged cover located at the front of the high mount stop light. This cover conceals the tether strap anchor bracket.

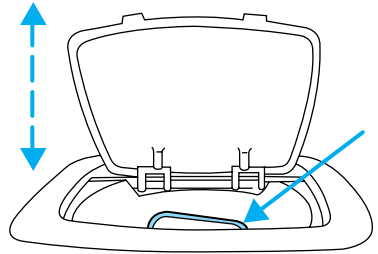

To prevent damage to the hinge, do not raise the hinged cover of the trim panel beyond its limit.

2. Install the tether strap bracket located directly below the cover. If the center seating position is not being used, the cover should be kept closed for a neat appearance.

# Starting

## PREPARING TO START YOUR VEHICLE

Engine starting is controlled by the ignition system. This system meets all Canadian Interference-Causing Equipment standard requirements regulating the impulse electrical field strength of radio noise.

When starting a fuel-injected engine, avoid pressing the accelerator before or during starting. Only use the accelerator when you have difficulty starting the engine. For more information on starting the vehicle, refer to *Starting the engine* in this chapter.



Extended idling at high engine speeds can produce very high temperatures in the engine and exhaust system, creating the risk of fire or other damage.



Do not park, idle, or drive your vehicle in dry grass or other dry ground cover. The emission system heats up the engine compartment and exhaust system, which can start a fire.



Do not start your vehicle in a closed garage or in other enclosed areas. Exhaust fumes can be toxic. Always open the garage door before you start the engine. See *Guarding against exhaust fumes* in this chapter for more instructions.



If you smell exhaust fumes inside your vehicle, have your dealer inspect your vehicle immediately. Do not drive if you smell exhaust fumes.

## Important safety precautions

A computer system controls the engine's idle revolutions per minute (RPM). When the engine starts, the idle RPM runs faster to warm the engine. If the engine idle speed does not slow down automatically, have the vehicle checked. Do not allow the vehicle to idle for more than ten minutes at fast rpm.

Before starting the vehicle:

1. Make sure all vehicle occupants have buckled their safety belts. For more information on safety belts and their proper usage, refer to the *Seating and safety restraints* chapter.

# Starting

2. Make sure the headlamps and vehicle accessories are off.

- Make sure the parking brake is set.

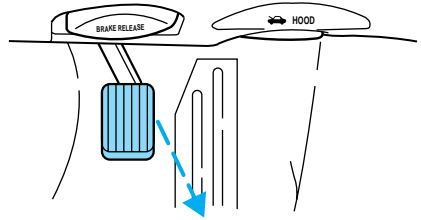

- Make sure the gearshift is in P (Park).

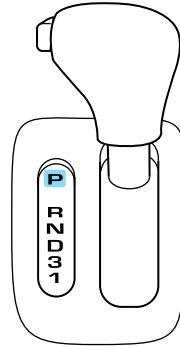

3. Turn the key to 4 (ON) without turning the key to 5 (START).

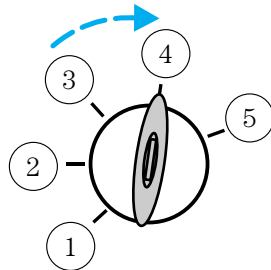

# Starting

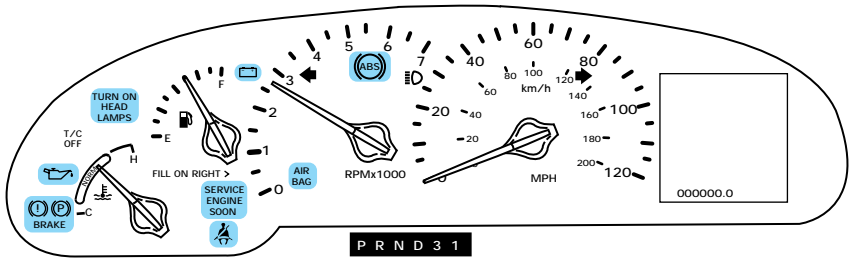

Make sure the corresponding lights illuminate briefly. If a light fails to illuminate, have the vehicle serviced.

- If the driver's safety belt is fastened, the light (  ) will not illuminate.

## STARTING THE ENGINE

1. Turn the key to 5 (START) without pressing the accelerator pedal and release as soon as the engine starts. The key will return to 4 (ON).

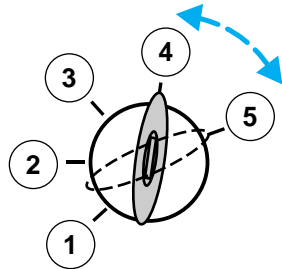

2. If the engine does not start within five seconds, wait ten seconds and try again.

3. If the engine does not start in two attempts or if the temperature is below  $-12^{\circ}\text{C}$  ( $10^{\circ}\text{F}$ ), depress the accelerator and start the engine while holding the accelerator down. Release the accelerator when the engine starts.

4. After idling for a few seconds, apply the brake and release the parking brake.

### Using the engine block heater (if equipped)

An engine block heater warms the engine coolant, which improves starting, warms up the engine faster and allows the heater-defroster system to respond quickly. Use of an engine block heater is strongly recommended if you live in a region where temperatures reach  $-23^{\circ}\text{C}$  ( $-10^{\circ}\text{F}$ ) or below.

For best results, plug the heater in at least three hours before starting the vehicle. Using the heater for longer than three hours will not harm the engine, so the heater can be plugged in the night before starting the vehicle.



To prevent electrical shock, do not use your heater with ungrounded electrical systems or two-pronged (cheater) adapters.

### Guarding against exhaust fumes

Although odorless and colorless, carbon monoxide is present in exhaust fumes. Take precautions to avoid its dangerous effects.



If you ever smell exhaust fumes of any kind inside your vehicle, have your dealer inspect and fix your vehicle immediately. Do not drive if you smell exhaust fumes. These fumes are harmful and could kill you.

Have the exhaust and body ventilation systems checked whenever:

- the vehicle is raised for service.
- the sound of the exhaust system changes.
- the vehicle has been damaged in a collision.

## Starting

### Important ventilating information

If the engine is idling while the vehicle is stopped in an open area for long periods of time, open the windows at least 2.5 cm (one inch).

Adjust the heating or air conditioning (if equipped) to bring in fresh air.

Improve vehicle ventilation by keeping all air inlet vents clear of snow, leaves and other debris.

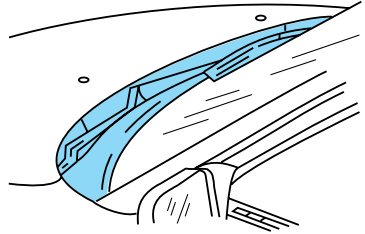

## BRAKES

Your brakes are self-adjusting. Refer to the “Service Guide” for scheduled maintenance.

Occasional brake noise is normal and often does not indicate a performance concern with the vehicle’s brake system. In normal operation, automotive brake systems may emit occasional or intermittent squeal or groan noises when the brakes are applied. Such noises are usually heard during the first few brake applications in the morning; however, they may be heard at any time while braking and can be aggravated by environmental conditions such as cold, heat, moisture, road dust, salt or mud. If a “metal-to-metal,” “continuous grinding” or “continuous squeal” sound is present while braking, the brake linings may be worn-out and should be inspected by a qualified service technician.

### Anti-lock brake system (ABS)

On vehicles equipped with an anti-lock braking system (ABS), a noise from the hydraulic pump motor and pulsation in the pedal may be observed during ABS braking events. Pedal pulsation coupled with noise while braking under panic conditions or on loose gravel, bumps, wet or snowy roads is normal and indicates proper functioning of the vehicle’s anti-lock brake system. If the vehicle has continuous vibration or shudder while braking, felt mainly in the steering wheel, the vehicle most likely needs service.

The ABS operates by detecting the onset of wheel lock up during brake applications and compensating for this tendency. The front wheels are prevented from locking even when the brakes are firmly applied. The accompanying illustration depicts the advantage of an ABS equipped vehicle (on bottom) to a non-ABS equipped vehicle (on top) during hard braking.

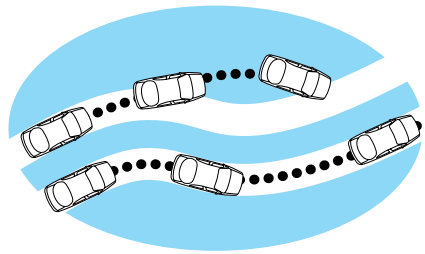

### ABS warning lamp

The  warning lamp in the instrument cluster illuminates for about five seconds when starting the vehicle. If an ABS fault is detected, the

## Driving

light will remain on and your vehicle should be serviced as soon as possible.

Normal braking is still effective unless the BRAKE warning lamp is also illuminated.



### Using ABS

- In an emergency or when maximum efficiency from the ABS is required, apply continuous full force on the brake. The ABS will be activated immediately, thus allowing you to retain full steering control of your vehicle and, providing there is sufficient space, will enable you to avoid obstacles and bring the vehicle to a controlled stop.
- We recommend that you familiarize yourself with this braking technique. However, avoid taking any unnecessary risks.

### Parking brake with auto-release

Apply the parking brake whenever the vehicle is parked.

To set the parking brake:

1. Move the gearshifter to P (Park).
2. Push pedal downward.

The BRAKE warning lamp in the instrument cluster illuminates and remains illuminated (when the ignition is turned ON) until the parking brake is fully released.

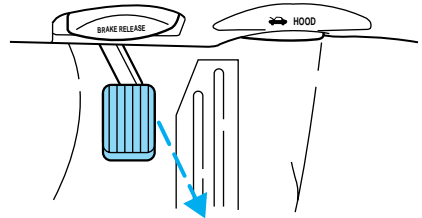

Always set the parking brake fully and make sure the gearshift is latched in P (Park). Turn off the ignition whenever you leave your vehicle.

The parking brake is not designed to stop a moving vehicle. However, if the normal brakes fail, the parking brake can be used to stop your vehicle in an emergency. Since the parking brake applies only the rear brakes, the vehicle's stopping distance will increase greatly and the handling of your vehicle will be adversely affected.



Your vehicle has an automatic parking brake release. To release the parking brake:

1. Turn the ignition to the RUN position.
2. Press the brake pedal.
3. Move the gearshifter from the P (Park) position to one of the forward gears (the parking brake will not release automatically when you shift into reverse). The brake pedal must remain pressed while the gearshifter is moved.

If the parking brake fails to release after completing this procedure, use the manual parking brake release lever.

Pull the lever to manually release the parking brake.

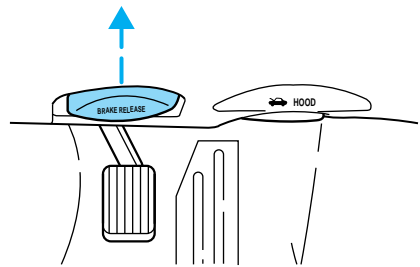

### TRACTION CONTROL™

Traction Control™ helps maintain the stability and steerability of your vehicle. It is especially useful on slippery and/or hilly road surfaces. The system operates by detecting and controlling wheel spin. The system borrows many of the electronic and mechanical elements already present in the anti-lock braking system (ABS).

Wheel-speed sensors allow excess front wheel spin to be detected by the Traction Control™ portion of the ABS computer. Any excessive wheel spin is controlled by automatically applying and releasing the front brakes in conjunction with engine torque reductions. Engine torque reduction is realized via the fully electronic spark and fuel injection systems. This process is very sensitive to driving conditions and very fast acting. The front wheels “search” for optimum traction several times a second and adjustment are made accordingly.

The Traction Control™ system will allow your vehicle to make better use of available traction on slippery surfaces. The system is a driver aid which makes your vehicle easier to handle primarily on snow and ice covered roads.

During Traction Control™ operation, TRACTION CONTROL ACTIVE is displayed on the message center. You may hear an electric motor type of

## Driving

sound coming from the engine compartment and the engine will not “rev-up” when you push further on the accelerator. This is normal system behavior.

If you should become stuck in snow or on a very slippery road surface, try switching the Traction Control™ system off. This may allow excess wheel spin to “dig” the vehicle out or enable a successful “rocking” maneuver. Refer to *Message center* in the *Instrumentation* chapter.

If the Traction Control™ system is cycled excessively, the brake portion of the system will shut down to prevent the front brakes from overheating. A limited Traction Control™ function using only engine torque reduction will still control wheels from over-spinning. When the front brakes have cooled down, the system will again function normally. Anti-lock braking is not affected by this condition and will function normally during the cool down period.

If a system fault is detected, CHECK TRACTION CONTROL is displayed on the message center and your vehicle should be serviced.

### **AIR SUSPENSION SYSTEM**

The air suspension system is designed to improve ride, handling and general vehicle performance during:

- certain road conditions
- steering maneuvers
- braking
- accelerations

This system keeps the rear of your vehicle at a constant level by automatically adding air or releasing air from the springs.

The air suspension shut-off switch is located on the left side of the trunk. If this switch is in the OFF position, the rear air suspension will not operate.



On vehicles equipped with Air Suspension, turn OFF the Air Suspension switch prior to jacking, hoisting or towing your vehicle.

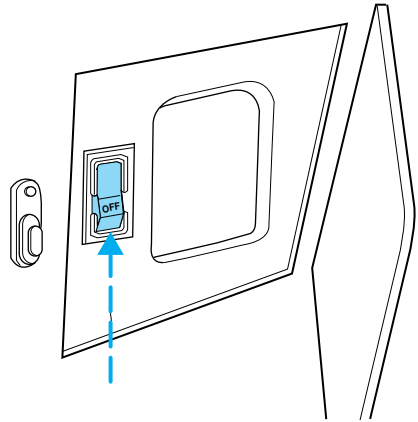

Normal vehicle operation does not require any action by the driver.

## AUTOMATIC TRANSAXLE OPERATION

### Brake-shift interlock

This vehicle is equipped with a brake-shift interlock feature that prevents the gearshift from being moved from P (Park) unless the brake pedal is pressed.

If you cannot move the gearshift out of P (Park) with the brake pedal depressed:

1. Apply the parking brake, turn ignition key to LOCK, then remove the key.
2. Insert the key and turn it to OFF. Apply the brake pedal and shift to N (Neutral).
3. Start the vehicle.

If it is necessary to use the above procedure to move the gearshift, it is possible that a fuse has blown and the vehicle's brakelamps may not be operating properly. Refer to *Fuses and relays* in the *Roadside emergencies* chapter.



Do not drive your vehicle until you verify that the brakelamps are working.

If your vehicle gets stuck in mud or snow it may be rocked out by shifting from forward and reverse gears in a steady pattern. Press lightly

## Driving

on the accelerator in each gear. Do not rock the vehicle for more than a few minutes, because it could damage the vehicle.



Always set the parking brake fully and make sure the gearshift is latched in P (Park). Turn off the ignition whenever you leave your vehicle.

### Driving with a 4-speed automatic transaxle

Your automatic overdrive transaxle provides fully automatic operation in either D (Overdrive) or 3 (Third). Driving with the shift selector in D (Overdrive) gives the best fuel economy for normal driving conditions. For manual control start in 1 (First) and then shift manually.

To put your vehicle in gear, start the engine, depress the brake pedal, then move gearshift out of P (Park).



Hold the brake pedal down while you move the gearshift lever from position to position. If you do not hold the brake pedal down, your vehicle may move unexpectedly and injure someone.

### Understanding gearshift positions

#### **P (Park)**

Always come to a complete stop before shifting into P (Park). Make sure the gearshift is securely latched in P (Park). This locks the transaxle and prevent the front wheels from rotating.

**P R N D 3 1**

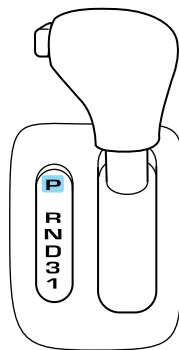

## **R (Reverse)**

With the gearshift in R (Reverse), the vehicle will move backward. You should always come to a complete stop before shifting into and out of R (Reverse).

P **R** N D 3 1

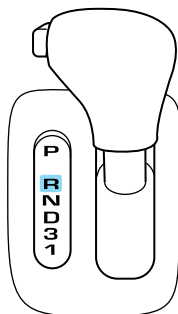

## **N (Neutral)**

With the gearshift in the N (Neutral) position, the vehicle can be started and is free to roll. Hold the brake pedal down while in this position.

P R **N** D 3 1

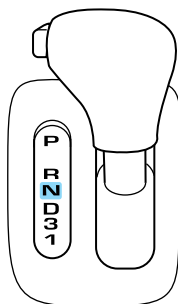

# Driving

## ***D (Overdrive)***

The overdrive position is the normal driving position for an automatic overdrive transaxle. It works the same way as 3 (Third) but shifts to a fourth gear — an overdrive gear — when your vehicle cruises at a constant speed for any length of time. This fourth gear will increase your fuel economy when you travel at cruising speeds.

P R N **D** 3 1

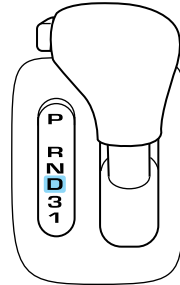

Overdrive may not be appropriate for certain terrains. If the transaxle shifts back and forth between third and fourth gears while you are driving hilly roads or if your vehicle requires additional power for climbing hills, shift into 3 (Third).

## ***When to use 3 (Third)***

3 (Third) eliminates the needless shifting back and forth between third and fourth gears that your vehicle may do when driving on hilly terrain. It also gives more engine braking than overdrive to slow your vehicle on downgrades.

P R N D **3** 1

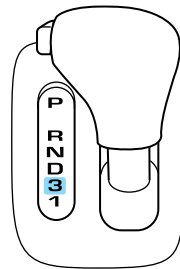

## 1 (First)

Use 1 (First) for when added engine braking is desired when descending steep hills.

The automatic transaxle will shift to the proper gear to ascend any grade without any need to shift to 1 (First).

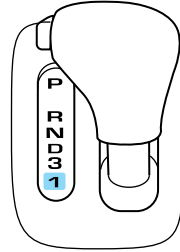
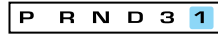

Do not go faster than 61 km/h (38 mph) when in this gear. You can upshift from 1 (First) to overdrive at any time.



When parking, do not use the gearshift in place of the parking brake. Always set the parking brake fully and make sure that the gearshift is securely latched in Park (P). Turn off the ignition whenever you leave your vehicle. Never leave your vehicle unattended while it is running. If you do not take these precautions, your vehicle may move unexpectedly and injure someone.

## DRIVING THROUGH WATER

Do not drive quickly through standing water, especially if the depth is unknown. Traction or brake capability may be limited and if the ignition system gets wet, your engine may stall. Water may also enter your engine's air intake and severely damage your engine.

If driving through deep or standing water is unavoidable, proceed very slowly. Never drive through water that is higher than the bottom of the hubs (truck)/wheel rims (car).

Once through the water, always try the brakes. Wet brakes do not stop the vehicle as effectively as dry brakes. Drying can be improved by moving your vehicle slowly while applying light pressure on the brake pedal.

# Driving

## VEHICLE LOADING

Before loading a vehicle, familiarize yourself with the following terms:

- **Base Curb Weight:** Weight of the vehicle including any standard equipment, fluids, lubricants, etc. It does not include passengers or aftermarket equipment.
- **Payload:** Combined maximum allowable weight of cargo, passengers and optional equipment. The payload equals the gross vehicle weight rating minus base curb weight.
- **GVW (Gross Vehicle Weight):** Base curb weight plus payload weight. The GVW is not a limit or a specification.
- **GVWR (Gross Vehicle Weight Rating):** Maximum total weight of the base vehicle, passengers, optional equipment and cargo. The GVWR is specific to each vehicle and is listed on the Safety Compliance Label on the driver's door pillar.
- **GAWR (Gross Axle Weight Rating):** Carrying capacity for each axle system. The GAWR is specific to each vehicle and is listed on the Safety Compliance Label on the driver's door pillar.
- **GCWR (Gross Combined Weight Rating):** Maximum combined weight of towing vehicle (including passengers and cargo) and the trailer. The GCWR indicates the maximum loaded weight that the vehicle is allowed to tow.
- **Maximum Trailer Weight Rating:** Maximum weight of a trailer the vehicle is permitted to tow. The maximum trailer weight rating is determined by subtracting the vehicle curb weight for each engine/transmission combination, any required option weight for trailer towing and the weight of the driver from the GCWR for the towing vehicle.
- **Maximum Trailer Weight:** maximum weight of a trailer the loaded vehicle (including passengers and cargo) is permitted to tow. It is determined by subtracting the weight of the loaded trailer towing vehicle from the GCWR for the towing vehicle.
- **Trailer Weight Range:** Specified weight range that the trailer must fall within that ranges from zero to the maximum trailer weight rating.

Remember to figure in the tongue load of your loaded trailer when figuring the total weight.





Do not exceed the GVWR or the GAWR specified on the Safety Compliance Certification Label.

Do not use replacement tires with lower weight capacities than the originals because they may lower the vehicle's GVWR and GAWR limitations. Replacement tires with a higher weight limit than the originals do not increase the GVWR and GAWR limitations.

## TRAILER TOWING

Your vehicle is classified as a light duty towing vehicle. Refer to the following chart for towing limits:

<b>Towing class</b>	Light duty
<b>Maximum gross trailer weight</b>	454/907 kg (1 000/2 000 lbs.)*
<b>Maximum tongue load</b>	45/91 kg (100/200 lbs.)
<b>Engine</b>	4.6L
<b>Hitch design</b>	Load carrying type
<b>Trailer-tow package option</b>	Not required
* Vehicle speed should not exceed 72 km/h (45 mph) when towing on grades. Limit maximum gross trailer weight to 454 kg (1 000 lbs.) and maximum tongue load to 45 kg (100 lbs.): (1) when you are towing a trailer on steep hills or on moderate hills for distances longer than 8 km (5 miles) or more and; (2) on very hot days (when the temperature is above 38°C [100°F]).	

Your vehicle does not come from the factory fully equipped to tow. However, you can contact your local Lincoln dealer to get the proper towing equipment. Do not tow a trailer until your vehicle has been driven at least 3 200 km (2 000 miles).

Towing a trailer places an additional load on your vehicle's engine, transmission, brakes, tires and suspension. Inspect these components carefully after towing.



Do not tow a trailer when using a temporary spare tire.

The amount of weight your loaded trailer should be no more than 907 kg (2 000 lbs.).

## Driving



Do not exceed the GVWR or the GAWR specified on the Safety Compliance Certification Label.



Towing trailers beyond the maximum recommended gross trailer weight could result in engine damage, transmission/axle damage, structural damage, loss of control, and personal injury.

### Preparing to tow

Use the proper equipment for towing a trailer, and make sure it is properly attached to your vehicle. See your dealer or a reliable trailer dealer if you require assistance.

#### **Hitches**

Do not use hitches that clamp onto the vehicle bumper. Use a load carrying hitch. You must distribute the load in your trailer so that 10 – 15% of the total weight of the trailer is on the tongue.

#### **Safety chains**

Always connect the trailer's safety chains to the vehicle. To connect the trailer's safety chains, cross the chains under the trailer tongue and allow slack for turning corners.

If you use a rental trailer, follow the instructions that the rental agency gives to you.

#### **Trailer brakes**

Electric brakes and manual, automatic or surge-type brakes are safe if installed properly and adjusted to the manufacturer's specifications. The trailer brakes must meet local and Federal regulations.



Do not connect a trailer's hydraulic brake system directly to your vehicle's brake system. Your vehicle may not have enough braking power and your chances of having a collision greatly increase.

The braking system of the tow vehicle is rated for operation at the GVWR not GCWR

#### **Trailer lamps**

Do not connect a trailer's lighting system directly to your vehicle's lighting system. To get the proper equipment for hooking up your

trailer's lamps, see your Lincoln dealer. Be sure to follow their instructions carefully.

If you do not install trailer lights correctly, you may cause damage to the vehicle's lighting system or other vehicle systems.

### **Driving while you tow**

Do not drive faster than 88 km/h (55 mph) when towing a trailer.

Speed control may shut off if you are towing on long, steep grades.

When towing a trailer:

- Shift out of D (Overdrive) and into 3 (Third) or a lower gear when towing up or down steep hills. This will eliminate excessive downshifting and upshifting for optimum fuel economy and transaxle cooling.
- Anticipate stops and brake gradually.

### **Servicing after towing**

If you tow a trailer for long distances, your vehicle will require more frequent service intervals. Refer to the Severe Duty Schedule in your "Service Guide" for more information.

### **Trailer towing tips**

- Practice turning, stopping and backing up in an area before starting on a trip to get the feel of the vehicle trailer combination. When turning, make wider turns so the trailer wheels will clear curbs and other obstacles.
- Allow more distance for stopping with a trailer attached.
- The trailer tongue weight should be 10–15% of the loaded trailer weight.
- After you have traveled 80 km (50 miles), thoroughly check your hitch, electrical connections and trailer wheel lug nuts.
- When stopped in traffic for long periods of time in hot weather, place the gearshift in P (Park) and increase idle speed. This aids engine cooling and air conditioner efficiency.
- Vehicles with trailers should not be parked on a grade. If you must park on a grade, place wheel chocks under the trailer's wheels.

# Driving

## FUEL CONSUMPTION

Fuel economy can be improved by avoiding:

- lack of regular, scheduled maintenance.
- excessive speed.
- rapid acceleration.
- extended idle.

## CHECKING YOUR HIGHWAY FUEL ECONOMY USING THE ELECTRONIC MESSAGE CENTER DISPLAY

The following procedure will allow you to accurately monitor your actual highway fuel economy. Since this procedure requires the vehicle speed control system to be set to highway speeds, it must be run only on suitable roadways where long distance speed control can be safely maintained.

You may notice gradual improvement in fuel economy over the course of your vehicle's break-in period (approximately 1 600 kilometers [1 000 miles]).

1. Set the speed control. Refer to *Speed control* in the *Controls and features* chapter.

2. Press the Distance to Empty (DTE) Economy (ECON) control until "Average Miles per Gallon" is displayed.



3. Press the RESET control to clear the system memory.



- *Actual highway fuel economy is now displayed.* This current average measure will change as the speed control system changes the engine speed to maintain a constant vehicle speed. This is most noticeable in hilly environments.

It is important to press the RESET control after setting the speed control to get accurate highway fuel economy readings.

## Roadside emergencies

### HAZARD FLASHER

For information on the hazard flasher control, refer to *Hazard lights control* in the *Roadside emergencies* chapter.

### FUEL PUMP SHUT-OFF SWITCH

If the engine cranks but does not start after a collision, the fuel pump shut-off switch may have been activated. The shut-off switch is a device intended to stop the electric fuel pump when your vehicle has been involved in a substantial jolt.

1. Turn the ignition to the OFF position.
2. Check the fuel system for leaks.
3. If no fuel leak is apparent, reset the fuel pump shut-off switch by pushing in the button on the switch.
4. Turn the ignition to the ON position. Pause for a few seconds and return the key to the OFF position.
5. Make a further check for leaks in the fuel system.

The fuel pump shut-off switch is located behind an access door to the left of the driver's seat on the B-pillar.

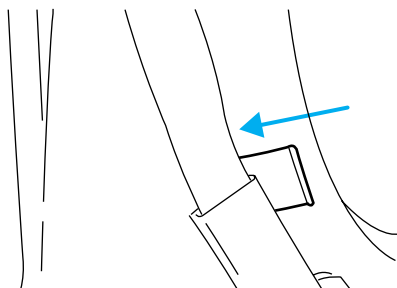

### FUSES AND RELAYS

#### Fuses

If electrical components in the vehicle are not working, a fuse may have blown. Blown fuses are identified by a broken wire within the fuse. Check the appropriate fuses before replacing any electrical components.

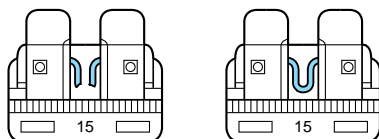

## Roadside emergencies



Always replace a fuse with one that has the specified amperage rating. Using a fuse with a higher amperage rating can cause severe wire damage and could start a fire.

### ***Standard fuse amperage rating and color***

<b>Fuse rating</b>	<b>Color</b>
5 amp	Tan
7.5 amp	Brown
10 amp	Red
15 amp	Light blue
20 amp	Yellow
20 amp fuse link	Light blue
25 amp	Natural
30 amp	Light green
30 amp fuse link	Pink
40 amp fuse link	Green
50 amp fuse link	Red
60 amp fuse link	Yellow
80 amp fuse link	Black
100 amp fuse link	Dark blue

### **Passenger compartment fuse panel**

The fuse panel is located below and to the left of the steering wheel by the brake pedal. Remove the panel cover to access the fuses.

To remove a fuse use the fuse puller tool provided on the fuse panel cover.

## Roadside emergencies

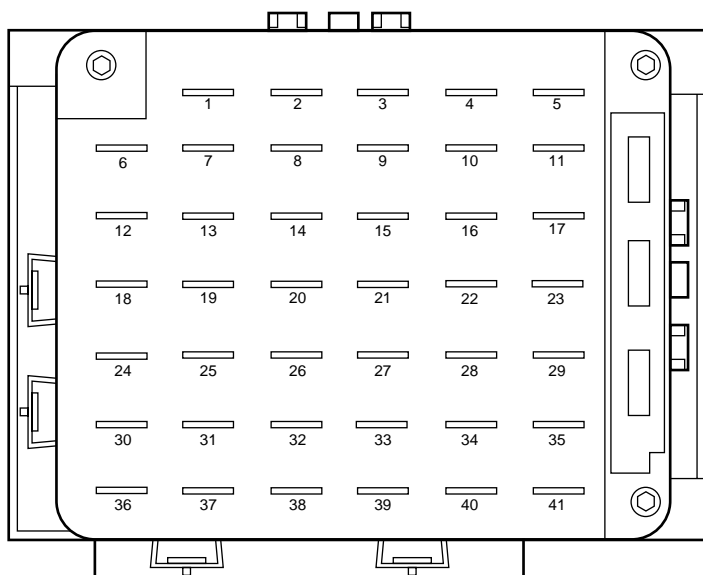

## Roadside emergencies

The fuses are coded as follows:

<b>Fuse/Relay Location</b>	<b>Fuse Amp Rating</b>	<b>Description</b>
1	10A	Lighting Control Module: Anti-Theft Indicator Lamp, PWM Dimming Output, Illumination Lamps for Microphone, RR and LR Door Ashtrays, Heated Seat Switches, Rear Defrost Control Switch, EATC Control Panel, Message Center Switches, Speed Control Switches, Cigar Lighter, Console and Ashtray
2	10A	Data Link Connector (DLC), Powertrain Control Module (PCM)
3	15A	Multi-Function Switch, Cornering Lamps, High Beam and Turn Signal Input to LCM
4	10A	Power Door Locks and Power Windows Switch Backlights, Radio, Mobile Telephone Transceiver, Lighting Control Module, (RUN/ACC Sense), RESCU, Electronic Day/Night Mirror



## Roadside emergencies

<b>Fuse/Relay Location</b>	<b>Fuse Amp Rating</b>	<b>Description</b>
5	10A	Virtual Image Instrument Cluster, Lighting Control Module (LCM RUN/START Sense), Autolamp Light Sensor
6	10A	Virtual Image Instrument Cluster, RF Park/Turn Lamp
7	20A	Power Point
8	20A	Fuel Filler Door Release Switch, Trunk Lid Relay
9	10A	Air Bag Diagnostic Monitor, EATC Module, Blower Motor Relay
10	30A	Windshield Wiper Motor, Windshield Wiper Module
11	10A	Ignition Coils, Radio Interference Capacitor, PCM Power Relay, Passive Anti-Theft System (PATS) Transceiver
12	10A	Lighting Control Module

## Roadside emergencies

<b>Fuse/Relay Location</b>	<b>Fuse Amp Rating</b>	<b>Description</b>
13	15A	Lighting Control Module (LCM): RF Turn Lamp, Right Turn Indicator (VIC), RR Side Marker Lamps, Tail Lamps, License Lamps, LR Stop/Turn Lamps, Clock Illumination
14	20A	Cigar Lighter
15	10A	ABS Evac and Fill Connector
16	30A	Moonroof Switch
17	-	NOT USED
18	10A	Lighting Control Module
19	10A	Lighting Control Module (LCM): Left Headlamp, DRL
20	15A	Multi-Function Switch: Flash to Pass, and Hazard Warning Input to LCM
21	-	NOT USED
22	-	NOT USED
23	10A	Digital Transmission Range Sensor
24	10A	Virtual Image Cluster-LF Turn Indicator, LF Turn Signal
25	10A	Lighting Control Module (LCM): Right Headlamp

## Roadside emergencies

<b>Fuse/Relay Location</b>	<b>Fuse Amp Rating</b>	<b>Description</b>
26	10A	Virtual Image Instrument Cluster, EATC Module
27	-	NOT USED
28	10A	Shift Lock Actuator, Vehicle Dynamic Module, Virtual Image Instrument Cluster, Rear Window Defrost, Heated Seat Switch Assembly, Low Tire Pressure Module
29	10A	Radio
30	10A	Heated Mirrors
31	15A	Lighting Control Module (LCM): FCU, Electronic Day/Night Mirror, RH and LH Courtesy Lamp, Door Courtesy Lamps, RH and LH Map Lamps, RR and LR Reading Lamps, RH and LH Visor Lamps, Storage Bin Lamps, Trunk Lid Lamp, Glove Box Lamp, Light Sensor Amplifier
32	15A	Speed Control DEAC. Switch, Brake On/Off (BOO) Switch
33	-	NOT USED

## Roadside emergencies

<b>Fuse/Relay Location</b>	<b>Fuse Amp Rating</b>	<b>Description</b>
34	15A	Console Shift Illumination, A/C Clutch Cycling Pressure Switch, A/C Clutch Relay (DTR) Sensor, Intake Manifold Runner Control, Backup Lamps
35	-	NOT USED
36	-	NOT USED
37	30A	Subwoofer Amplifier, Radio
38	10A	Analog Clock, CD Player, Mobile Telephone Transceiver, RESCU
39	10A	Power Door Locks, Power Seats, Power Mirrors, Keyless Entry, LF Seat Module, LF Door Module
40	10A	Cornering Lamps
41	20A	Door Locks

# Roadside emergencies

## Power distribution box

The power distribution box is located in the engine compartment near the battery. The power distribution box contains high-current fuses that protect your vehicle's main electrical systems from overloads.



Always disconnect the battery before servicing high current fuses.



Always replace the cover to the Power Distribution Box before reconnecting the battery or refilling fluid reservoirs.

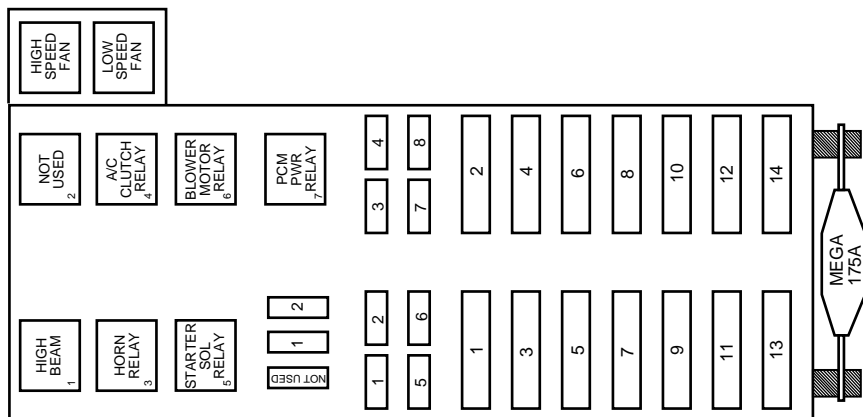

## Roadside emergencies

The high-current fuses are coded as follows:

Fuse/Relay Location	Fuse Amp Rating	Description
	175	Generator/Voltage Regulator
1	30A**	Driver's Seat Module
2	30A**	Passenger's Seat Module
3	40A**	Ignition Switch
4	40A**	Ignition Switch
5	40A**	Driver Window
6	-	NOT USED
7	30A**	PCM Power
8	40A**	Rear Window Defrost Control
9	60A**	I/P Fuse Panel
10	60A**	LCM Power
11	60A**	Compressor Relay
12	60A**	Anti-Lock Brake Control Module, ABS EVAC and Fill Connector
13	40A**	Blower Motor Relay
14	60A**	Dual Auxiliary Relay Box
1	30A*	PCM CAM
2	20A*	ALT SENSE
3	30A*	Rear Passenger Window
4	30A*	Air Suspension
5	10A*	Air Bag
6	20A*	Horns
7	15A*	High Beam

## Roadside emergencies

Fuse/Relay Location	Fuse Amp Rating	Description
8	30A*	Front Passenger Window
1	-	A/C Diode
2	-	PCM Diode
* Mini Fuses ** Maxi Fuses		

### CHANGING THE TIRES

If you get a flat tire while driving, do not apply the brake heavily. Instead, gradually decrease your speed. Hold the steering wheel firmly and slowly move to a safe place on the side of the road.

#### Tire change procedure

1. Park on a level surface, activate hazard flashers and set parking brake.
2. Place gearshift lever in P (Park).
3. Remove the spare tire, jack and lug wrench.
4. Remove the center ornament from the aluminum wheel with the tapered end of the wheel nut wrench that came with your vehicle. Insert and twist the handle, then pry against the wheel.

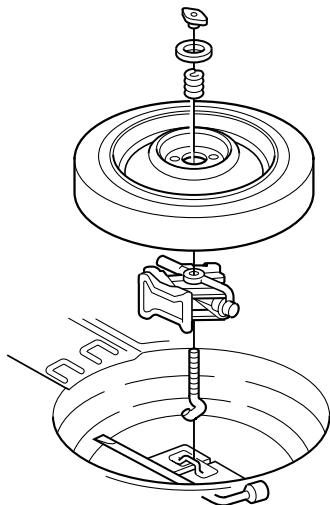

## Roadside emergencies

5. Loosen each wheel lug nut one-half turn counterclockwise but do not remove them until the wheel is raised off the ground. Refer to *Anti-theft lug nuts* for information on removing anti-theft lug nuts.

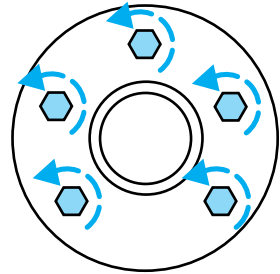

On vehicles equipped with Air Suspension, turn OFF the Air Suspension switch prior to jacking, hoisting or towing your vehicle.

Refer to *Air suspension system* in the *Driving* chapter for more information.

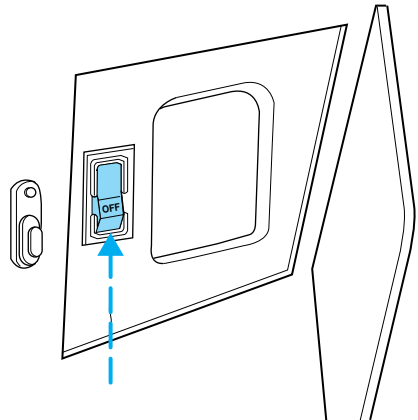

6. Put the jack in the jack notch next to the door closest to the tire you are changing. Turn the jack handle clockwise until the wheel is completely off the ground.

7. Remove the lug nuts with the lug wrench.

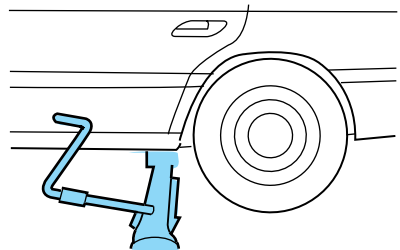

8. Replace the flat tire with the spare tire, making sure the valve stem is facing outward. Reinstall lug nuts until the wheel is snug against the hub. Do not fully tighten the lug nuts until the wheel has been lowered.

9. Lower the wheel by turning the jack handle counterclockwise.



## Roadside emergencies

10. Remove the jack and fully tighten the lug nuts in the order shown.

11. Put flat tire, jack and lug wrench away.

12. Turn on the air suspension switch.

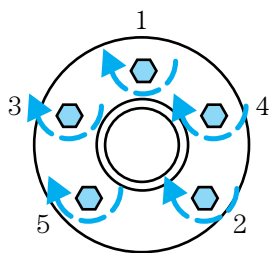

### Anti-theft lug nuts (if equipped)

If your vehicle is equipped with this feature, one of the lug nuts on each wheel must be removed and replaced with a special key. The key and registration card are attached to the lug wrench and stored with the spare tire. If you lose the key, send the registration card to the manufacturer (not the dealer) to get a replacement key. If the lug wrench/lug nut key assembly is lost, see your nearest Ford or Lincoln/Mercury dealer who has access to the master set of keys. **Do not use an impact wrench with the anti-theft key.**

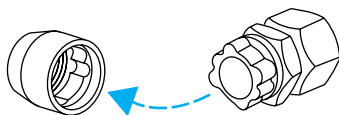

If you lose the key, send the registration card to the manufacturer (not the dealer) to get a replacement key. If the lug wrench/lug nut key assembly is lost, see your nearest Ford or Lincoln/Mercury dealer who has access to the master set of keys. **Do not use an impact wrench with the anti-theft key.**

### Removing the anti-theft lug nut

1. Insert the key over the locking lug nut. Make sure you hold the key square to the lug nut. If you hold the key at an angle, you could damage the key and the lug nut.

2. Place the lug nut wrench over the lug nut key and apply pressure on the key with the wrench.

3. Turn the wrench in a counterclockwise direction to remove the lug nut.

### Reinstalling the anti-theft lug nut

1. Insert the key over the locking lug nut.

2. Place the lug nut wrench over the lug nut key and apply pressure on the key with the wrench.

3. Install the lug nut.

## Roadside emergencies

### JUMP STARTING YOUR VEHICLE



The gases around the battery can explode if exposed to flames, sparks, or lit cigarettes. An explosion could result in injury or vehicle damage.



Do not push start your vehicle. You could damage the catalytic converter.



Batteries contain sulfuric acid which burns skin, eyes, and clothing.

### Preparing your vehicle

Also see the label on the battery.

1. Use only a 12-volt supply to start your vehicle. If you connect your battery to a 24-volt power supply you can damage your starter, ignition system and other electrical components.
2. Do not disconnect the battery of the disabled vehicle as this could damage the vehicle's electrical system.
3. Park the booster vehicle close to the hood of the disabled vehicle making sure they **do not** touch. Set the parking brake on both vehicles and stay clear of the engine cooling fan and other moving parts.
4. Check all battery terminals and remove any excessive corrosion before you attach the battery cables.
5. Turn the heater fan on in both vehicles to protect any electrical surges. Turn all other accessories off.

## Roadside emergencies

### Connecting the jumper cables

1. Position the vehicles so that they do not touch one another.
2. Switch off the engine. Switch off any unnecessary electrical equipment.
3. Connect the positive (+) terminal of the discharged battery (1) to the positive (+) terminal of the booster battery (2).
4. Connect one end of the second lead to the negative (-) terminal of the booster battery (3) and the other end to the alternator mounting brace stud of the engine to be started (4), not to the negative (-) terminal of the discharged battery.
5. Make sure that the jump leads are clear of moving parts of the engine.

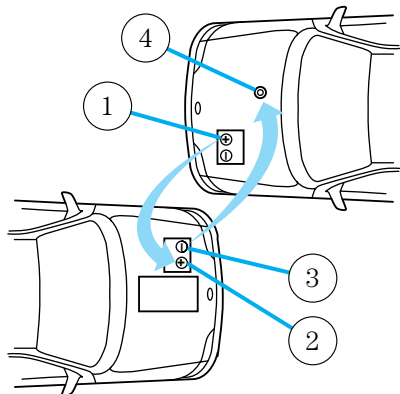

Do not connect the end of the second cable to the negative (-) terminal of the battery to be jumped. A spark may cause an explosion of the gases that surround the battery.

### Jump starting

1. Start the booster vehicle and run the engine at moderately increased speed.
2. Start the engine of the vehicle with the discharged battery.
3. Once the engine has been started, run both vehicles for a further three minutes before disconnecting the leads.

# Roadside emergencies

## Removing the jumper cables

1. Remove the jumper cables in reverse order. Take the cable off the alternator mounting brace stud (1) first, followed by the cable on the negative (-) booster battery terminal (2).
2. Remove the cable from the positive (+) terminal of the booster battery (3) and then the discharged battery (4).
3. After the disabled vehicle has been started, allow it to idle for a while so the engine can “relearn” its idle conditions.

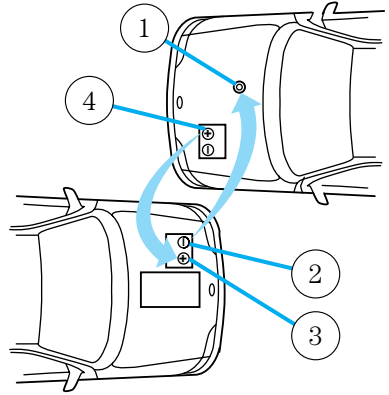

## WRECKER TOWING

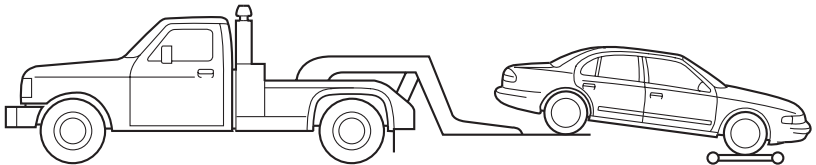
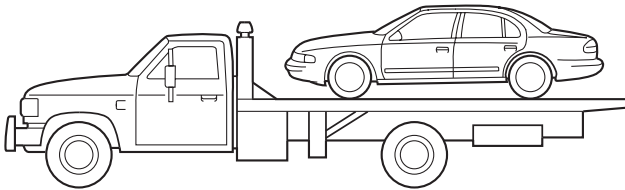
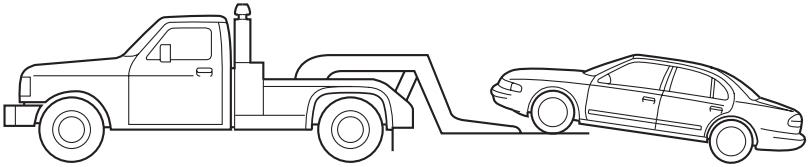

## **Roadside emergencies**

If you need to have your vehicle towed, contact a professional towing service or, if you are a member, your roadside assistance center. It is recommended that your vehicle be towed with a wheel lift or flatbed equipment.

When calling for a tow truck, tell the operator what kind of vehicle you have. A towing manual is available from Ford Motor Company for all authorized tow truck operators. Have your tow truck driver refer to this manual for proper hook-up and towing procedures for your vehicle.

## Maintenance and care

### SERVICE RECOMMENDATIONS

To help you service your vehicle:

- We highlight do-it-yourself items in the engine compartment for easy location.
- We provide a “Service Guide” which makes tracking routine service easy.

If your vehicle requires professional service, your dealership can provide necessary parts and service. Check your “Warranty Guide” to find out which parts and services are covered.

Use only recommended fuels, lubricants, fluids and service parts conforming to specifications. Motorcraft parts are designed and built to provide the best performance in your vehicle.

### PRECAUTIONS WHEN SERVICING YOUR VEHICLE

Be especially careful when inspecting or servicing your vehicle.

- Do not work on a hot engine.
- When the engine is running, avoid wearing loose clothing, jewelry or long hair that could get caught up in moving parts.
- Do not work on a vehicle with the engine running in an enclosed space, unless you are sure you have enough ventilation.
- Keep all lit cigarettes, open flames and other lit material away from the battery and all fuel related parts.

If you disconnect the battery, the engine must “relearn” its idle conditions before your vehicle will drive properly, as explained in the *Battery* section in this chapter.

### Working with the engine off

1. Set the parking brake, and ensure the gearshift is securely latched in park.
2. Turn off the engine and remove the key.
3. Block the wheels to prevent the vehicle from moving unexpectedly.

### Working with the engine on

1. Set the parking brake and ensure the gearshift is securely latched in P (Park).
2. Block the wheels to prevent the vehicle from moving unexpectedly.

## Maintenance and care



Do not start your engine with the air cleaner removed and do not remove it while the engine is running.

### OPENING THE HOOD

1. Inside the vehicle, pull the hood release handle located under the bottom of the instrument panel.
2. Go to the front of the vehicle and release the auxiliary latch that is located under the front center of the hood. Lift the hood until the lift cylinders hold it open.

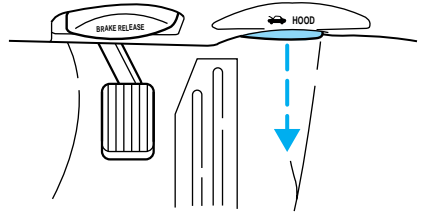

### IDENTIFYING COMPONENTS IN THE ENGINE COMPARTMENT

#### 4.6L DOHC V8 engine

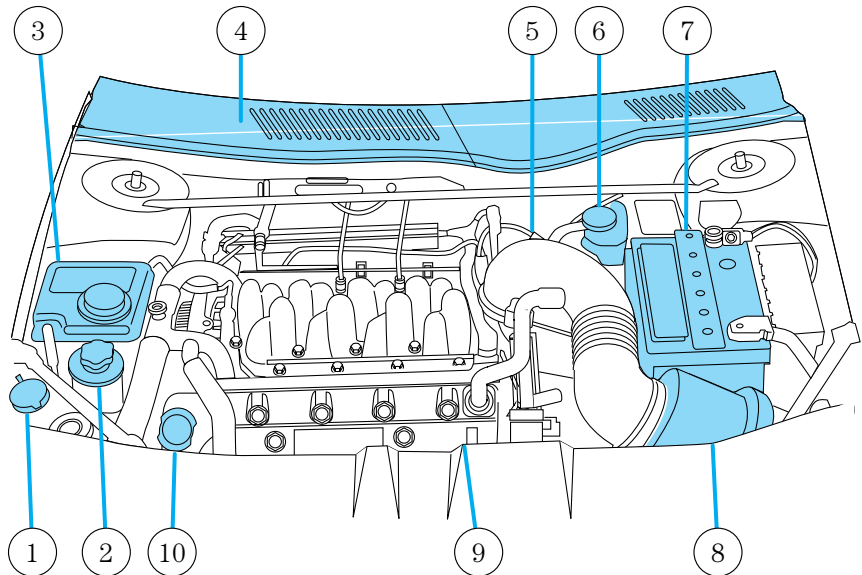

1. Windshield washer fluid reservoir
2. Power steering fluid reservoir

## Maintenance and care

3. Engine coolant reservoir
4. Passenger compartment air filter assembly
5. Transaxle fluid dipstick
6. Brake fluid reservoir
7. Battery
8. Air filter assembly
9. Engine oil dipstick
10. Engine oil fill cap

### ENGINE OIL

#### Checking the engine oil

Check the engine oil each time you fuel your vehicle.

1. Make sure the vehicle is on level ground.
2. Turn the engine off and wait a few minutes for the oil to drain into the oil pan.
3. Set the parking brake and ensure the gearshift is securely latched in P (Park).
4. Open the hood. Protect yourself from engine heat.
5. Locate and carefully remove the engine oil level indicator (dipstick).

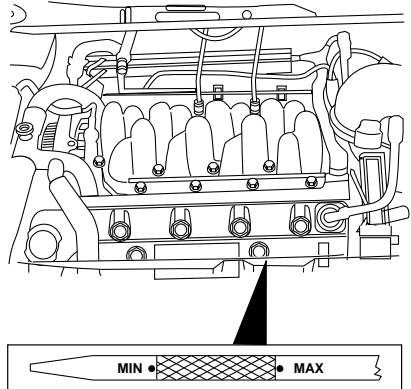

6. Wipe the indicator clean. Insert the indicator fully, then remove it again.



## Maintenance and care

- If the oil level is **between the MIN and MAX marks**, the oil level is acceptable. **DO NOT ADD OIL.**
- If the oil level is below the MIN mark, add enough oil to raise the level within the MIN-MAX range.

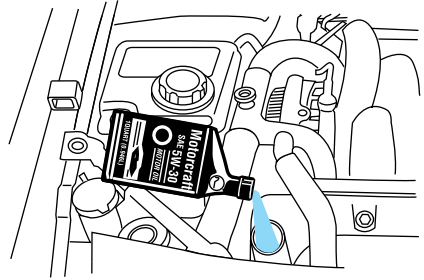

- Oil levels above the MAX mark may cause engine damage. Some oil must be removed from the engine by a service technician.
7. Put the indicator back in and ensure it is fully seated.

### Adding engine oil

1. Check the engine oil. For instructions, refer to *Checking the engine oil* in this chapter.
2. If the fluid level is not within the normal range, add only certified engine oil of the preferred viscosity. Add engine oil through the oil filler cap. Remove the filler cap and use a funnel to pour oil in the opening.
3. Recheck the oil level. Make sure the oil level is not above the MAX mark on the dipstick.

### Engine oil recommendations

Look for this certification mark.

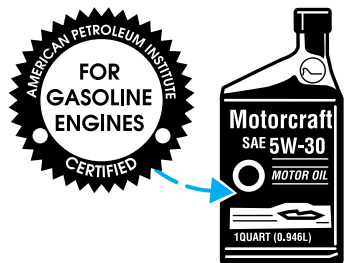

Ford oil specification is WSS-M2C153-G.

## Maintenance and care

Use SAE 5W-30 motor oil certified for gasoline engines by the American Petroleum Institute.

Do not use supplemental engine oil additives, oil treatments or engine treatments. They are unnecessary and could, under certain conditions, lead to engine damage which is not covered by your warranty.

### Changing the engine oil and filter

Change your engine oil and filter according to the appropriate schedule listed in the “Service Guide”.

Ford production and aftermarket (Motorcraft) oil filters are designed for added engine protection and long life. If a replacement oil filter is used that does not meet Ford material and design specifications, startup engine noises or knock may be experienced.

It is recommended you use the appropriate Motorcraft oil filter (or another brand meeting Ford specifications) for your engine application.

### CHECKING AND ADDING BRAKE FLUID

Brake fluid should be checked and refilled as needed at least once each year:

1. Clean the reservoir cap before removal to prevent dirt or water from entering the reservoir.
2. Visually inspect the fluid level.
3. If necessary, add brake fluid until the level reaches MAX. Do not fill above this line.
4. Use only a DOT 3 brake fluid certified to meet Ford specifications. Refer to *Lubricant specifications* in the *Capacities and specifications* chapter.

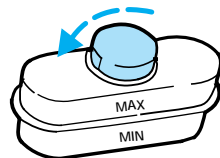
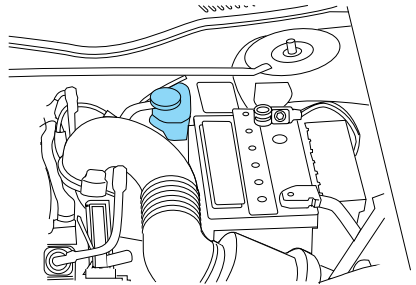

## Maintenance and care



Brake fluid is toxic.



If you use a brake fluid that is not DOT 3, you will cause permanent damage to your brakes.



Do not let the reservoir for the master cylinder run dry. This may cause the brakes to fail.

### WINDSHIELD WASHER FLUID

#### Checking and adding washer fluid

Check the washer fluid whenever you stop for fuel. The reservoir is highlighted with a  symbol.

If the level is low, add enough fluid to fill the reservoir. In very cold weather, do not fill the reservoir all the way.

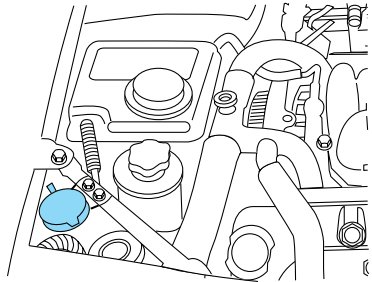

Do not put engine coolant in the container for the windshield washer fluid.

### ENGINE COOLANT

Check the level of the coolant in the reservoir at least once a month. Be sure to read and understand *Precautions when servicing your vehicle* in this chapter.

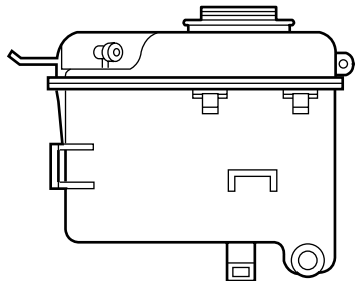

## Maintenance and care

If the engine coolant has not been checked for a long period of time, the engine coolant reservoir may eventually empty. If this occurs, a **LOW ENGINE COOLANT** warning illuminate in the message center and you will need to add engine coolant to the coolant reservoir. For more information on engine coolant maintenance, refer to *Adding engine coolant* in this chapter.

Automotive fluids are not interchangeable; do not use engine coolant, antifreeze or windshield washer fluid outside of its specified function and vehicle location.

### Adding engine coolant



Do not put engine coolant in the container for the windshield washer fluid.

If sprayed on the windshield, engine coolant could make it difficult to see through the windshield.

When the engine is cool, add a 50/50 mixture of engine coolant and water to the engine coolant recovery reservoir-**DO NOT ADD DIRECTLY TO THE RADIATOR**. Add straight water only in an emergency, but you should replace it with a 50/50 mixture of coolant and distilled water as soon as possible.

Check the coolant level in the coolant recovery reservoir the next few times you drive the vehicle. If necessary, add enough of a 50/50 mixture of coolant and water to bring the liquid level to the fill line on the reservoir.

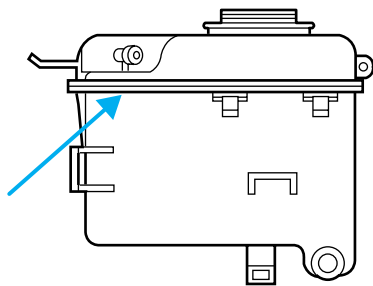

Never remove the coolant recovery cap while the engine is running or hot.

If you must remove the coolant recovery cap, follow these steps to avoid personal injury:

1. Before you remove the cap, turn the engine off and let it cool.

## Maintenance and care

2. When the engine is cool, wrap a thick cloth around the cap. Slowly turn cap counterclockwise.
3. Step back while the pressure releases.
4. When you are sure that all the pressure has been released, turn it counterclockwise and remove it.

Use Ford Premium Cooling System Fluid E2FZ-19549-AA (in Canada, Motorcraft CXC-8-B) or an equivalent premium engine coolant that meets Ford specification ESE-M97B44-A. Ford Premium Engine Coolant is an optimized formula that will protect all metals and rubber elastomers used in Ford cooling systems for four years or 80,000 km (50,000 miles).

Do not use alcohol or methanol antifreeze or any engine coolants mixed with alcohol or methanol antifreeze. Do not use supplemental coolant additives in your vehicle. These additives may harm your engine cooling system. The use of an improper coolant may void your warranty of your vehicle's engine cooling system.

### Recycled engine coolant

Ford Motor Company recommends that Ford and Lincoln-Mercury dealers use recycled engine coolant produced by Ford-approved processes. Not all coolant recycling processes produce coolant which meets Ford specification ESE-M97B44-A, and use of such coolant may harm engine and cooling system components.



Always dispose of used automotive fluids in a responsible manner. Follow your community's regulations and standards for recycling and disposing of automotive fluids.

### Coolant refill capacity

To find out how much fluid your vehicle's cooling system can hold, refer to *Refill capacities* in the *Capacities and specifications* chapter.

Have your dealer check the engine cooling system for leaks if you have to add more than a liter (quart) of engine coolant per month.

### Severe winter climate

If you drive in extremely cold climates (less than  $-36^{\circ}\text{C}$  [ $-34^{\circ}\text{F}$ ]), it may be necessary to increase the coolant concentration above 50%. Refer to the chart on the coolant container to ensure the coolant concentration in your vehicle is such that the coolant will not freeze at the temperature level in which you drive during winter months. Never increase the engine

## Maintenance and care

coolant concentration above 60%. Leave a 50/50 mixture of engine coolant and water in your vehicle year-round in non-extreme climates.

### CHECKING AND ADDING POWER STEERING FLUID

Check the power steering fluid at least twice a year. If adding fluid is necessary, use only MERCON® ATF power steering fluid.

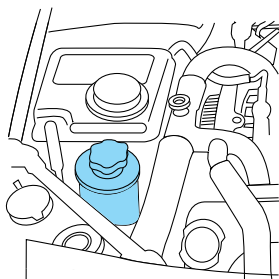

1. Start the engine and let it run until it reaches normal operating temperature (the engine coolant temperature gauge will be near the center of the NORMAL band).
2. While the engine idles, turn the steering wheel left and right several times.
3. Turn the engine off.
4. Check the fluid level in the reservoir. It should be between the MIN and MAX lines. Do not add fluid if the level is in this range.

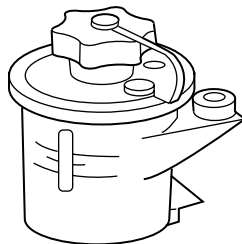

5. If the fluid is low, add fluid in small amounts, continuously checking the level until it reaches the range between the MIN and MAX lines. Be sure to put the cap back on the reservoir.

### TRANSMISSION FLUID

#### Checking and adding automatic transmission fluid

Follow the scheduled service intervals outlined in the “Service Guide.”

## Maintenance and care

Before adding any fluid, **make sure the correct type is used**. The type of fluid used is normally indicated on the dipstick and/or dipstick handle and also in the *Lubricant specifications* section in the *Capacities and specifications* chapter.

Do not drive the vehicle if the fluid level is below the hole at the bottom of the dipstick and outside temperatures are above 10°C (50°F).

Your transmission does not use up fluid. However, it is recommended that you check the transmission fluid at least twice a year. The fluid level should be checked if the transmission is not working properly, i.e., if the transmission slips or shifts slowly or if you notice some sign of fluid leakage.

Transmission fluid should be checked at normal operating temperatures 66°C-77°C (150°F-170°F) on a level surface. The normal operating temperature can be reached after approximately 32 km (20 miles) of driving.

If your vehicle has been operated for an extended period at high speeds, in city traffic during hot weather or pulling a trailer, the vehicle should be turned off for about 30 minutes to allow the fluid to cool before checking.

1. Park the vehicle on a level surface and engage the parking brake.
2. With the parking brake engaged and your foot on the brake pedal, start the engine and move the gearshift lever through all of the gear ranges. Allow sufficient time for each gear to engage.
3. Latch the gearshift lever in P (Park) and leave the engine running.
4. Remove the dipstick, wiping it clean with a clean, dry lint free rag.
5. Install the dipstick making sure it is fully seated in the filler tube.
6. Remove the dipstick and inspect the fluid level. The fluid level should be in the crosshatched area on the dipstick.



7. If necessary, add fluid in .25L (1/2 pint) increments through the filler tube until the level is correct.

## Maintenance and care

8. If an overfill occurs, excess fluid should be removed by a qualified technician. **An overfill condition of transmission fluid may cause shift and/or engagement concerns and/or possible damage.**

If the fluid level is above the crosshatch (hot operating range) area after driving the vehicle for approximately 30 km (20 miles), excess transmission fluid should be removed by a qualified technician.

### BATTERY

Your vehicle may be equipped with a Superstart maintenance-free battery. If the original equipment battery needs replacing, it may be replaced with a low-maintenance battery. The low-maintenance battery normally does not require additional water during its life of service. However, for severe usage or in high temperature climates, check your battery electrolyte level, at least every 24 months or 40,000 km (24,000 miles). Keep the electrolyte in each cell up to the “level” indicator. Do not overfill the battery cells.

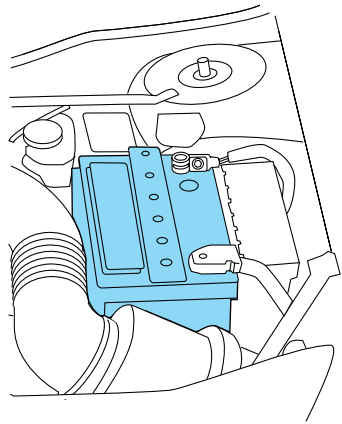

If the electrolyte level in the battery is low, you can add plain tap water to the battery, as long as you do not use hard water (water with a high alkali content). If possible, however, try to only fill the battery cells with distilled water. If the battery needs water often, have the charging system checked.

For longer, trouble-free operation, keep the top of the battery clean and dry. Also, make certain the battery cables are always tightly fastened to the battery terminals.

If you see any corrosion on the battery or terminals, remove the cables from the terminal(s) and clean with a wire brush. You can neutralize the acid with a solution of baking soda and water. Reinstall the cables when you are done cleaning them, and apply a small quantity of grease to the top of each battery terminal to help prevent corrosion.



## Maintenance and care

### **If your battery has a cover/shield, make sure it is reinstalled after the battery is replaced.**

Because your vehicle's engine is electronically controlled by a computer, some control conditions are maintained by power from the battery. When the battery is disconnected or a new battery is installed, the engine must relearn its idle conditions before your vehicle will drive properly. To begin this process:

1. Put the gearshift in P (Park), turn off all accessories and start the vehicle.
  2. Let the engine idle for at least one minute.
  3. The relearning process will automatically complete as you drive the vehicle.
- If you do not allow the engine to relearn its idle, the idle quality of your vehicle may be adversely affected until the idle is eventually relearned.
  - If the battery has been disconnected or a new battery has been installed, the clock and the preset radio stations must be reset once the battery is reconnected.
  - Always dispose of automotive batteries in a responsible manner. Follow your community's standards for disposal. Call your local recycling center to find out more about recycling automotive batteries.



# Maintenance and care

## CABIN AIR FILTER

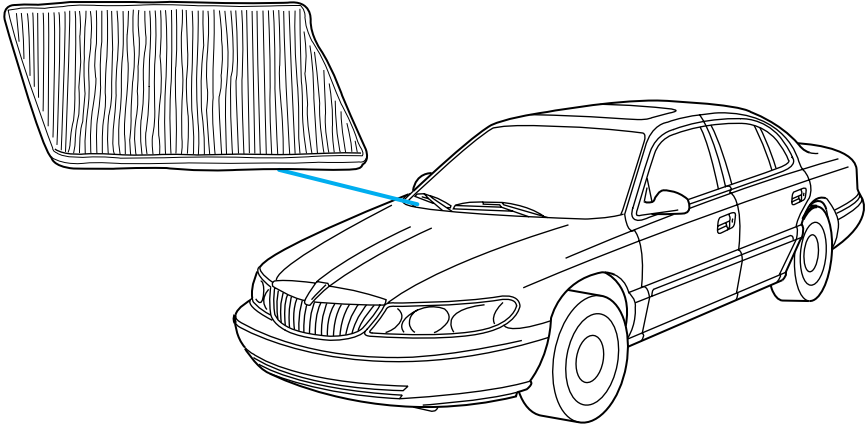

The cabin air filter restricts the entry of airborne dust and pollen particles. The filter is located just in front of the windshield under the cowl vent screen on the passenger side of the vehicle.

To replace the filter, perform the following procedure:

1. In order to gain better access to the filter, turn the ignition key to ON, then turn the wipers on. When the wipers reach the middle of the windshield (wipers in straight up position), turn the ignition to OFF.
2. Release and open the hood.

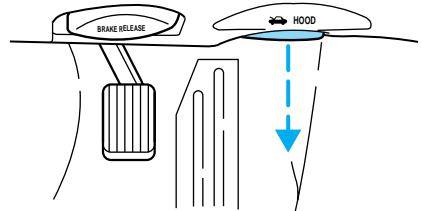

## Maintenance and care

3. Pull the rubber cowl seal (number 1 in figure) away from the cowl vent screen. Remove the right half of the cowl vent screen (number 2 in figure) by placing your hand underneath the cowl vent screen and lifting straight up to release the four spring clips.

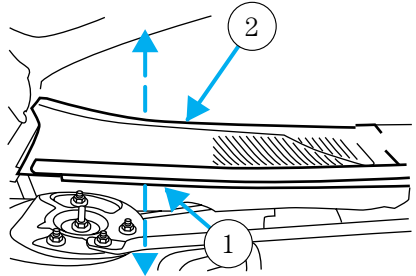

4. Remove the water shield (number 3 in figure) by disengaging the two water shield locking tabs (number 4 in figure), then sliding the water shield toward the front of the vehicle. After the locking tabs are disengaged from the water shield, lift the water shield up and away from the vehicle.

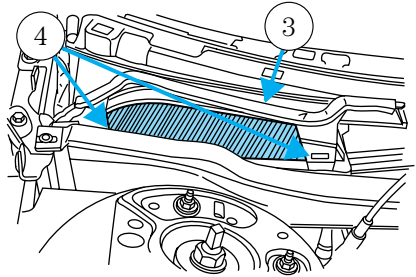

5. Remove the filter. Reverse the procedure to install the new filter.

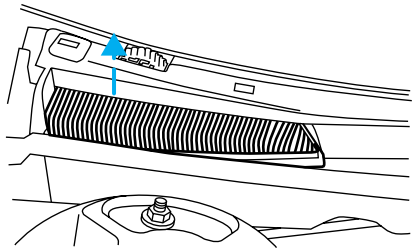

Be careful when installing the new filter. Avoid bending or tearing the filter and make sure it is fully seated in its mounting location after installation.

## WINDSHIELD WIPER BLADES

Check the wiper blades at least twice a year or when they seem less effective. Substances such as tree sap and some hot wax treatments used by commercial car washes reduce the effectiveness of wiper blades.

## Maintenance and care

### Checking the wiper blades

If the wiper blades do not wipe properly, clean both the windshield and wiper blades using undiluted windshield wiper solution or a mild detergent. Rinse thoroughly with clean water. To avoid damaging the blades, do not use fuel, kerosene, paint thinner or other solvents.

### Changing the wiper blades

When replacing wiper blade assemblies, always use a Motorcraft part or equivalent. To make replacing the wipers easy, turn the ignition to ACC, then turn the wipers on. When the wipers reach the vertical position, turn the ignition to LOCK.

To replace the wiper blades:

1. Pull the wiper arm away from the windshield and lock into the service position.
2. Turn the blade at an angle from the wiper arm. Push the lock pin with a screwdriver to release the blade and pull the wiper blade down toward the windshield to remove it from the arm.
3. Attach the new wiper to the wiper arm and press it into place until a click is heard.

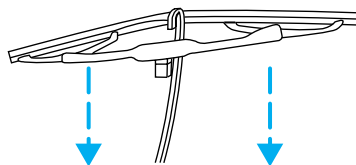
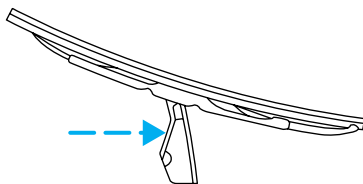

### SECURITIRE (IF EQUIPPED)

SecuriTires are designed to allow you to continue driving your vehicle a limited number of miles when one of your vehicle's tires is at low or even zero air pressure.

At zero pressure, the SecuriTires will provide you with a minimum driving capability of approximately 30 km (20 miles). How you drive and the actual amount of air pressure left in your tires will determine exactly how many miles can be driven.

To extend the mileage and help prevent damage to low or deflated tires:

## Maintenance and care

- do not exceed 90 km/h (55 mph). Drive at a reduced rate of speed, if possible.
- avoid excessive hard steering and braking maneuvers, if possible.
- stop periodically to allow the tires to cool down.

### Pressure alert system (if equipped)

Each of your SecuriTires is monitored by a low tire pressure sensor. A warning will appear in the overhead console when the pressure in one of your tires drops below acceptable levels or if the system has malfunctioned.

This device complies with Part 15 of the FCC rules and with RS-210 of Industry Canada. Operation is subject to the following two conditions: (1) This device may not cause harmful interference, and (2) This device must accept any interference received, including interference that may cause undesired operation.

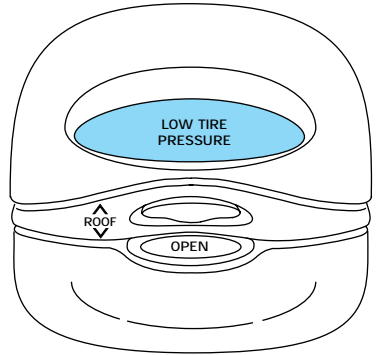

### Maintenance warning

The LOW TIRE PRESSURE warning will illuminate and stay on when one of your vehicle's tires drops below 124 kPa (18 psi). The warning light will also come on and stay lit if the Pressure Alert System has malfunctioned.

If this warning appears, check the pressure in your tires as soon as possible and adjust any tire that is low to the recommended air pressure level.

If the warning remains on after you have adjusted the tires to the recommended air pressure levels, take your vehicle to an authorized Lincoln/Mercury dealer for service.

### Flat tire warning

If the sensors detect a tire pressure lower than 68 kPa (10 psi), the LOW TIRE PRESSURE warning will appear in the overhead console and the message WARNING LOW TIRE PRESSURE will be displayed in the message center, indicating an impending flat tire. If this condition occurs,

## Maintenance and care

your SecuriTire requires service as soon as possible. Refer to *Servicing your SecuriTires*.

The Pressure Alert System will activate only when the vehicle is moving faster than 15 km/h (10 mph).

### Servicing your SecuriTires

If you cannot service your SecuriTire immediately, replace it with your temporary spare as soon as safely possible.

Your temporary spare tire can be used until your SecuriTire has been repaired.

It is recommended that you always have your SecuriTires serviced by an authorized Michelin tire dealer. **Each SecuriTire is equipped with a pressure sensor around the wheel rim. This sensor could be damaged when removing and installing the tire.** Servicing a SecuriTire at locations other than your Michelin tire dealer may adversely affect your warranty.

If you have questions concerning your SecuriTires or servicing, please call the Michelin Tire Information Line at 1-800-847-3435 or contact your local Michelin tire dealer.

### INFORMATION ABOUT TIRE QUALITY GRADES

New vehicles are fitted with tires that have their Tire Quality Grade (described below) molded into the tire's sidewall. These Tire Quality Grades are determined by standards that the United States Department of Transportation has set.

Tire Quality Grades apply to new pneumatic tires for use on passenger cars. They do not apply to deep tread, winter-type snow

tires, space-saver or temporary use spare tires, tires with nominal rim diameters of 10 to 12 inches or limited production tires as defined in Title 49 Code of Federal Regulations Part 575.104(c)(2).

**U.S. Department of Transportation-Tire quality grades:** The U.S. Department of Transportation requires Ford to give you the following information about tire grades exactly as the government has written it.

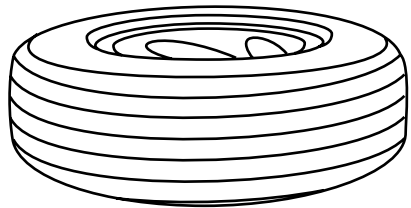

## Maintenance and care

### Treadwear

The treadwear grade is a comparative rating based on the wear rate of the tire when tested under controlled conditions on a specified government test course. For example, a tire grade 150 would wear one and one-half (1 1/2) times as well on the government course as a tire grade 100. The relative performance of tires depends upon the actual conditions of their use, however, and may depart significantly from the norm due to variations in driving habits, service practices, and differences in road characteristics and climate.

### Traction A B C

The traction grades, from highest to lowest are A, B, and C, and they represent the tire's ability to stop on wet pavement as measured under test surfaces of asphalt and concrete. A tire marked C may have poor traction performance.



The traction grade assigned to this tire is based on braking (straight ahead) traction tests and does not include cornering (turning) traction.

### Temperature A B C

The temperature grades are A (the highest), B, and C, representing the tire's resistance to the generation of heat and its ability to dissipate heat when tested under controlled conditions on a specified indoor laboratory test wheel. Sustained high temperature can cause the material of the tire to degenerate and reduce tire life, and excessive temperature can lead to sudden tire failure. The grade C corresponds to a level of performance which all passenger car tires must meet under the Federal Motor Vehicle Safety Standard No. 109. Grades B and A represent higher levels of performance on the laboratory test wheel than the minimum required by law.



The temperature grade for this tire is established for a tire that is properly inflated and not overloaded. Excessive speed, underinflation, or excessive loading, either separately or in combination, can cause heat buildup and possible tire failure.

## Maintenance and care

### SERVICING YOUR TIRES

#### Checking the tire pressure

- Use an accurate tire pressure gauge.
- Check the tire pressure when tires are cold, after the vehicle has been parked for at least one hour or has been driven less than 5 km (3 miles).
- Adjust tire pressure to recommended specifications found on the Safety Compliance Certification Label located on the right rear door jamb.



Improperly inflated tires can affect vehicle handling and can fail suddenly, possibly resulting in loss of vehicle control.

#### Tire rotation

Because your vehicle's tires perform different jobs, they often wear differently. To make sure your tires wear evenly and last longer, rotate them as indicated in the "Service Guide." If you notice that the tires wear unevenly, have them checked.

- Four tire rotation

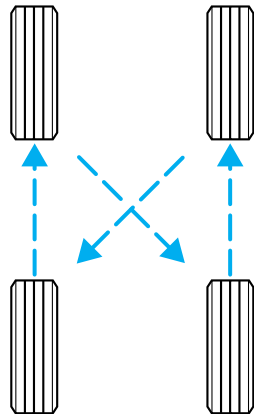



## Maintenance and care

### Replacing the tires

Replace the tires when the wear band is visible through the tire treads.

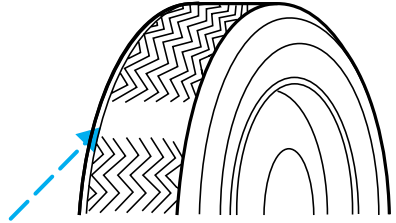

Failure to follow these precautions may adversely affect the handling of the vehicle and make it easier to lose control and roll over.

Tires that are larger or smaller than your vehicle's original tires may also affect the accuracy of your speedometer.

### SNOW TIRES AND CHAINS



Driving too fast for conditions creates the possibility of loss of vehicle control. Driving at very high speeds for extended periods of time may result in damage to vehicle components.



Snow tires must be the same size and grade as the tires you currently have on your vehicle.

Do not use any type of tire chains on this vehicle. This includes both conventional and cable-type chains.

The tires on your vehicle have all-weather treads that provide traction in rain or snow. However, during the winter months in some climates, you may need to use snow tires.

## Maintenance and care

### WHAT YOU SHOULD KNOW ABOUT AUTOMOTIVE FUELS

#### Important safety precautions



Do not overfill the fuel tank. The pressure in an overfilled tank may cause leakage and lead to fuel spray and fire.



If you do not use the proper fuel cap, the pressure in the fuel tank can damage the fuel system or cause it to work improperly in a collision.



The fuel system may be under pressure. If the fuel cap is venting vapor or if you hear a hissing sound, wait until it stops before completely removing the cap.



Automotive fuels can cause serious injury or death if misused or mishandled.

Observe the following guidelines when handling automotive fuel:

- Extinguish all smoking materials and any open flames before fueling your vehicle.
- Always turn off the vehicle before fueling.
- Automotive fuels can be harmful or fatal if swallowed. If fuel is swallowed, call a physician immediately, even if no symptoms are immediately apparent. The toxic effects of fuel may not be visible for hours.
- Fuels can also be harmful if absorbed through the skin. If fuel is splashed on the skin, promptly remove contaminated clothing and wash skin thoroughly with soap and water.
- If fuel is splashed in the eyes, remove contact lenses, flush with water for 15 minutes and seek medical attention.

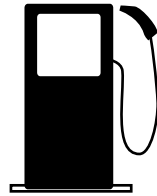

## Maintenance and care

- Be particularly careful if you are taking “Antabuse” or other forms of disulfiram for the treatment of alcoholism. Breathing gasoline vapors or skin contact could cause an adverse reaction. Consult a physician immediately.

### Choosing the right fuel

Use only UNLEADED FUEL. The use of leaded fuel is prohibited by law and could damage your vehicle.

Your vehicle was not designed to use fuel or fuel additives with metallic compounds, including manganese-based compounds containing MMT.

Vehicles certified to California emission standards (indicated on the underhood Vehicle Emissions Control Information label) are designed to operate on California reformulated gasolines. If California reformulated gasoline is not available when you refuel, your vehicle can be operated on non-California fuels. However, even though your engine will perform adequately on other gasolines, the performance of the emission control devices and systems may be adversely affected.

Repair of damage caused by using a fuel that your vehicle was not designed for may not be covered by your warranty.

### Octane recommendations

Your vehicle is designed to use “Premium” gasoline for optimum performance with an (R+M)/2 octane rating of 91 or higher.

Gasolines with lower octane ratings

can be used, but performance may decrease. We do not recommend gasolines labeled as “Premium” in high altitude areas that are sold with octane ratings less than 91.

Do not be concerned if your vehicle sometimes knocks lightly. However, if it knocks heavily under most driving conditions on fuel with the recommended octane, see your dealer or a qualified service technician to prevent any engine damage.

### Fuel quality

If you are experiencing starting, rough idle or hesitation driveability problems during a cold start, try a different brand of gasoline. If the problems persist, see your dealer or a qualified service technician.

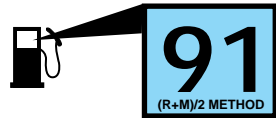

## Maintenance and care

The American Automobile Manufacturers Association (AAMA) issued a gasoline specification to provide information on high quality fuels that optimize the performance of your vehicle. We recommend the use of gasolines that meet the AAMA specification if they are available.

It should not be necessary to add any aftermarket products to your fuel tank if you continue to use a high-quality fuel.

### Cleaner air

Ford approves the use of gasolines to improve air quality, including reformulated gasolines that contain oxygenates up to 10% ethanol or 15% MTBE.

Do not use gasolines containing methanol, which can damage critical fuel system components. Damage resulting from the use of methanol may not be covered by your warranty.

### Running out of fuel

Avoid running out of fuel because this situation may have an adverse effect on modern powertrain components.

You may need to crank the engine several times before the system starts to pump fuel from the tank to the engine. If you run out of fuel, your Service Engine Soon light may come on. For more information on the Service Engine Soon light, refer to the *Instrumentation* chapter.

### Calculating fuel economy

To accurately calculate your vehicle's fuel economy:

1. Fill the tank completely and record the initial odometer reading.
2. Each time you fill the tank, record the amount of fuel added (in liters or gallons).
3. After at least three to five fuel tank fill-ups, fill the fuel tank and record the current mileage reading.
4. Use one of the following equations to calculate fuel economy.

Liters used  $\times 100 \div$  Total kilometers traveled

Total miles traveled  $\div$  Total gallons used

Keep a record for at least one month. This will provide an accurate estimate of the vehicle's fuel economy.

## Maintenance and care

### EMISSION CONTROL SYSTEM

Your vehicle is equipped with various emission control components and a catalytic converter which will enable your vehicle to comply with applicable exhaust emission standards. To make sure that the catalytic converter and other emission control components continue to work properly:

- Use only unleaded fuel.
- Avoid running out of fuel.
- Do not turn off the ignition while your vehicle is moving, especially at high speeds.
- Have the services listed in your “Service Guide” performed according to the specified schedule.

The Scheduled Maintenance Services listed in the “Service Guide” are required because they are considered essential to the life and performance of your vehicle and to its emissions system.

If other than Ford, Motorcraft or Ford authorized parts are used for maintenance replacements or for service of components affecting emission control such non-Ford parts should be equivalent to genuine Ford Motor Company parts in performance and durability.



Do not park, idle, or drive your vehicle in dry grass or other dry ground cover. The emission system heats up the engine compartment and exhaust system, which can start a fire.

Watch for fluid leaks, strange odors, smoke, loss of oil pressure, the charging system warning light, the “Service Engine Soon” light or the temperature warning light. These events could indicate that the emission control system is not working properly.



If you smell exhaust fumes of any kind inside your vehicle, have the dealer inspect and fix your vehicle immediately. Do not drive if you smell exhaust fumes. These fumes are harmful and could kill you.

Do not make any unauthorized changes to your vehicle or engine. By law, vehicle owners and anyone who manufactures, repairs, services, sells, leases, trades vehicles, or supervises a fleet of vehicles are not permitted to intentionally remove an emission control device or prevent it from working. Information about your vehicle’s emission system is on

## Maintenance and care

the Vehicle Emission Control Information Decal located on or near the engine. This decal identifies engine displacement and gives some tune up specifications.

Please consult your “Warranty Guide” for complete emission warranty information.

### Readiness for inspection/maintenance (I/M) testing

In some localities, it may be a legal requirement to pass an I/M test of the on-board diagnostic (OBD-II) system. If your “check engine/service engine soon” light is on, reference the applicable light description in the *Warning Lights and Chimes* section of your owners guide. Your vehicle may not pass the I/M test with the “check engine/service engine soon” light on.

If the vehicle’s powertrain system or its battery has just been serviced, the OBD-II system is reset to a “not ready for I/M test” condition. To ready the OBD-II system for I/M testing, a minimum of 30 minutes of city and highway driving is necessary as described below:

- First, at least 10 minutes of driving on an expressway or highway.
- Next, at least 20 minutes driving in stop and go, city type traffic with at least four idle periods.

Allow the vehicle to sit for at least eight hours without starting the engine. Then, start the engine and complete the above driving cycle. The engine must warm up to its normal operating temperature. Once started, do not turn off the engine until the above driving cycle is complete.

## EXTERIOR BULBS

### Replacing headlamp bulbs



Handle a halogen headlamp bulb carefully and keep out of children’s reach. Grasp the bulb only by its plastic base and do not touch the glass. The oil from your hand could cause the bulb to break the next time the headlamps are operated.

To remove the headlamp bulb:

1. Make sure headlamp switch is in OFF position.
2. Lift the hood and remove the plastic sight shield covering the back of the headlamps by lifting up on the rear corners to release the velcro attachments. Lift the shield and pull towards the windshield.

## Maintenance and care

3. At the back of the headlamp, pull back and up slightly on the two right angle brackets to release the headlamp assembly from the vehicle.
4. Carefully pull the headlamp assembly away from the vehicle to expose the back of the bulb and wiring connector.
5. Disconnect the electrical connector from the bulb by pulling the connector rearward.

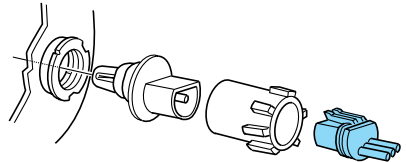

6. Remove the bulb retaining ring by rotating it counterclockwise (when viewed from the rear) about an eighth of a turn to free it from the bulb socket, and by sliding the ring off the plastic base. Keep the ring because it will be used again to retain the new bulb.

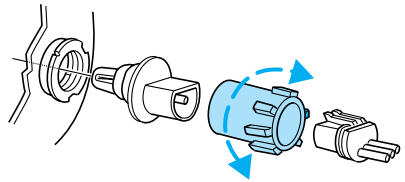

7. Remove the old bulb from its socket by gently pulling it straight back out of the socket. Do not turn the bulb while removing it.

To install the new bulb:

1. With the flat side of the bulb's plastic base facing upward, insert the glass end of the bulb into the socket. You may need to turn the bulb left or right to line up the grooves in the plastic base with the tabs in the socket. When the grooves are aligned, push the bulb into the socket until the plastic base contacts the rear of the socket.

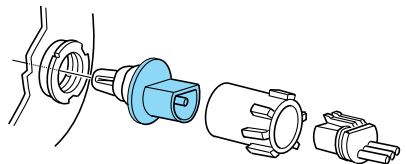

2. Slip the bulb retaining ring over the plastic base until it contacts the rear of the socket by rotating it clockwise until you feel a "stop."
3. Push the electrical connector into the rear of the plastic base until it snaps, locking it into position.
4. Before reinstalling the plastic sight shield, make sure the sight shield tabs are properly seated under the grille molding.

## Maintenance and care

5. Turn the headlamps on and make sure they work properly. If the headlamp was correctly aligned before you changed the bulb, you should not need to align it again.

### AIMING THE HEADLAMPS

Your vehicle is equipped with a Vehicle Headlamp Aim Device (VHAD) on each headlamp. Each headlamp may be properly aimed in the vertical (up/down) and the horizontal (left/right) directions using your VHAD system. The headlamps on your vehicle are properly aimed at the assembly plant.

A bubble (vertical indicator) that is not centered between the two red lines does not necessarily indicate out-of-aim headlamps. If your vehicle is not positioned on a level surface, the slope will be included in the vertical indication. Therefore, vertical and horizontal headlamp adjustment should be performed only when the beam direction appears to be incorrect.

You will need one 4 mm wrench or socket to make the adjustments.

If the vehicle has been in an accident, the vehicle's front structure should be properly aligned before aiming the headlamps.

#### Horizontal aim adjustment

1. With the hood open remove the protective cover, locate the horizontal indicator and adjusting screw. They are located below the viewing hole at the rear of the headlamp assembly.

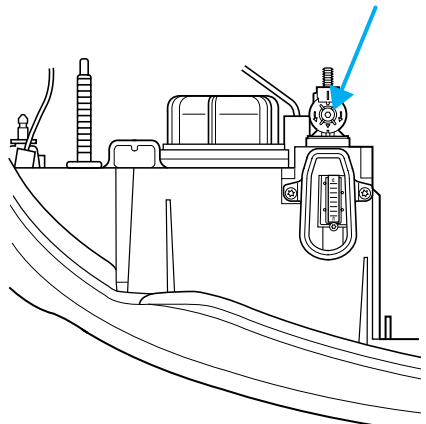



## Maintenance and care

2. Use a 4mm wrench or socket to turn the horizontal adjusting screw until the “0” mark on the yellow dial lines up with the reference mark on the marker (as shown) when viewed directly from above.

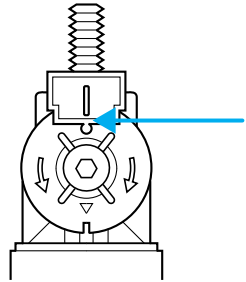

Turning the horizontal adjusting screw in the direction of the arrow changes the horizontal aim as shown.

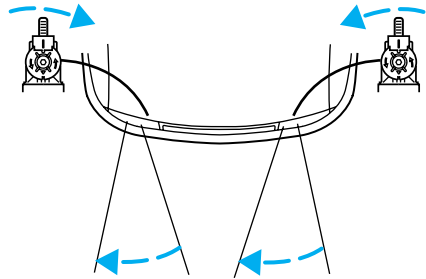

### Vertical aim adjustment

1. Park the vehicle on a level surface.
2. With the hood open, locate the bubble level and vertical adjustment screw. The adjustment screw is located on the outboard side of the headlamp.

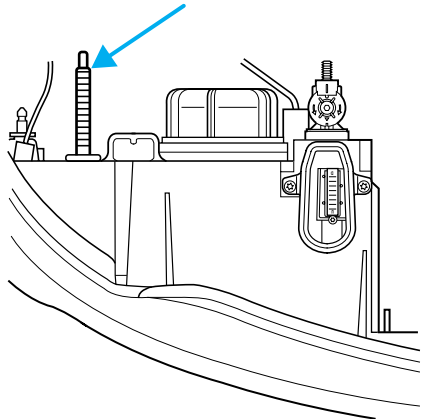

## Maintenance and care

- The “U” and “D” on the bubble indicate the directional change (up or down) of the vertical aim.
- Use a 4 mm wrench or socket to turn the vertical adjusting screw until the bubble is centered between the two red lines which represents the “0” mark position.

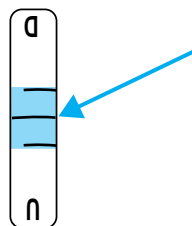

When the horizontal and vertical indicators are set to the “0” mark, the headlamp has been properly aimed.

- Replace the protective cover.

### REPLACING THE INTERIOR BULBS

Check the operation of the following interior bulbs frequently:

- interior overhead lamp
- map lamp

### Using the right bulbs

Function	Trade Number
Headlamp	9007
Cornering lamp (front)	3156K
Backup lamp	3156
High-mount brakelamp	912
Park/turn lamp (front)	3157K
License plate lamp	168
Luggage compartment lamp (decklid ajar)	912
Side marker (front)	194NA
Side marker (rear)	916
Stoplamp and tail lamp	3157K
Redundant turn lamp (rear)	3157K
Glovebox lamp	194
Ash receptacle	1445
Ash tray (rear)	37
Cigar lighter (console)	1893

## Maintenance and care

Function	Trade Number
Door mounted lamp (front)	214-2
Illuminated visor mirror	74
Overhead console reading lamp (without moon roof)	912
Passenger assist handle (rear seat)	211-2
To replace all instrument panel lights - see your dealer.	

### CLEANING AND CARING FOR YOUR VEHICLE

Refer to the “Customer Assistance Guide” for a list of Ford-approved cleaners, polishes and waxes.

#### Washing your vehicle

Wash your vehicle regularly with cold or lukewarm water. Never use strong detergents or soap. If your vehicle is particularly dirty, use a quality car wash detergent. Always use a clean sponge, washing glove or similar device and plenty of water for best results. To avoid spots, avoid washing when the hood is still warm, immediately after or during exposure to strong sunlight.

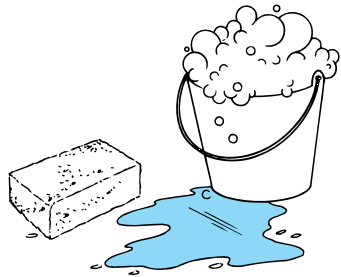

During winter months, it is especially important to wash the vehicle on a regular basis. Large quantities of dirt and road salt are difficult to remove and also cause damage to the vehicle. Remove any exterior accessories, such as antennas, before entering a car wash.

After washing, apply the brakes several times to dry them.

#### Waxing your vehicle

Wax when water stops beading on the surface. This could be every three or four months, depending on operating conditions.

Use only carnauba or synthetic-based waxes. Remove any bugs and tar before waxing vehicle. Use cleaning fluid or alcohol with a clean cloth to remove. Use tar remover to remove any tar spots.

## Maintenance and care

### Repairing paint chips

Minor scratches or paint damage from road debris may be repaired with touch-up paint, repair foil or aerosol paint spray from the Ford accessory line. Observe the application instructions on the products.

Remove particles such as bird droppings, tree sap, insect remains, tar spots, road salt and industrial fallout immediately.

### Cleaning the wheels

Wash with the same detergent as the body of your vehicle. Do not use acid-based wheel cleaners, steel wool, fuel or strong detergents. Never use abrasives that will damage the finish of special wheel surfaces. Use a tar remover to remove grease and tar.

### Cleaning the engine

Engines are more efficient when they are clean because grease and dirt buildup keep the engine warmer than normal. When washing:

- Take care when using a power washer to clean the engine. The high pressure fluid could penetrate the sealed parts and cause damage.
- Do not spray with cold water to avoid cracking the engine block or other engine components.

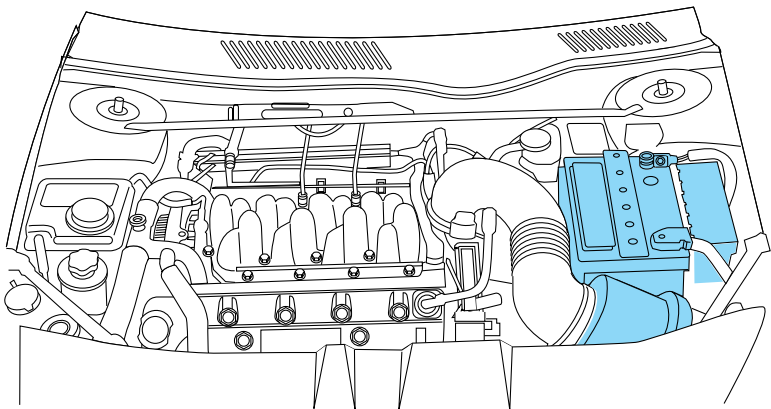

- Cover the highlighted areas to prevent water damage when cleaning the engine.

## Maintenance and care

- Never wash or rinse the engine while it is running; water in the running engine may cause internal damage.

### Cleaning plastic exterior parts

Use vinyl cleaner for routine cleaning. Clean with a tar remover if necessary. Do not clean plastic parts with thinners, solvents or petroleum-based cleaners.

### Cleaning the exterior lamps

Wash with the same detergent as the exterior of your vehicle. Use glass cleaner or tar remover if necessary.

To avoid scratching the lamps, do not use a dry paper towel, chemical solvents or abrasive cleaners.

### Cleaning the wiper blades

If the wiper blades do not wipe properly, clean the windshield and wiper blades with undiluted windshield wiper solution or a mild detergent. Rinse thoroughly with clean water. To avoid damaging the blades, do not use fuel, kerosene, paint thinner or other solvents.

### Cleaning the instrument panel

Clean with a damp cloth, then dry with a dry cloth.

Avoid cleaner or polish that increases the gloss of the upper portion of the instrument panel. The dull finish in this area helps protect the driver from undesirable windshield reflection.

### Cleaning and maintaining the safety belts

Clean the safety belts with a mild soap solution recommended for cleaning upholstery or carpets. Do not bleach or dye the belts, because these actions may weaken the belt webbing.

Check the safety belt system periodically to make sure there are no nicks, wear or cuts. If your vehicle has been involved in an accident, refer to the *Safety belt maintenance* section in the *Seating and safety restraints* chapter.

### Underbody

Flush the complete underside of vehicle frequently. Keep body drain holes unplugged. Inspect for road damage.

## Maintenance and care

### Cleaning leather seats

For routine cleaning, wipe the surface with a soft, damp cloth. For more thorough cleaning, wipe the surface with a leather and vinyl cleaner or a mild soap.

**The type of scrubbing pad is very critical because the common 3M “Scotch Brite” green pad is too aggressive and will damage the leather surface.**

- Spray a small amount of the leather cleaner on the pad and rub the area to be cleaned with the pad using a circular motion. Only clean 1/4 of the area at a time. For heavily soiled areas, spray the cleaner directly onto the leather (two squirts should be adequate) and rub with the pad. Repeat if necessary.
- Use a soft, damp cloth to remove the loosened dirt and foam.
- Dry with a soft cloth.

**Do not use household cleaners, glass cleaner, alcohol solutions or cleaner intended for vinyl, rubber or plastics. These products can damage the leather.**

**In some instances, color or dye transfer can occur when wet clothing (wool, denim, leathers or other non-colorfast garments) comes in contact with leather upholstery. If this occurs, the leather should be cleaned immediately to avoid permanent staining.**

“Tanners Preserve Leather Cleaner” (product number AS-300) is available from “First Brands” by calling 1-800-726-1001. This product may also be available at many local automotive after market stores.

3M “Type T” Clean And Finish Scrubbing Pads (UPC 04011-01276) are available through your local 3M distributor. Call 1-800-742-9649 for the nearest distributor in your area.

PART NUMBER	PART NAME
(Obtain Locally)	Tanners Preserve Leather Cleaner
(Obtain Locally)	3M “Type T” Clean and Finish Scrubbing Pads

### Woodtone trim

Wipe stains with a soft cloth and a multi-purpose cleaning solution.

## Maintenance and care

### **Inside windows**

Use glass cleaner for the inside windows if they become fogged.

### **Cleaning mirrors**

Do not clean your mirrors with a dry cloth or abrasive materials. Use a soft cloth and mild detergent and water. Be careful when removing ice from outside mirrors because you may damage the reflective surface.

## Capacities and specifications

### MOTORCRAFT PART NUMBERS

Component	4.6L DOHC V8 engine
Air filter	FA-1615
Cabin air filter	FP-5
Fuel filter	FG-800A
Battery	BXT-65-750
Oil filter	FL-820-S
Spark plugs*	AWSF-32EE**
* Refer to Vehicle Emissions Control Information (VECI) decal for spark plug gap information.	
**If a spark plug needs to be replaced, use only spark plugs with the same service part number suffix letter "EE" as shown on the engine decal.	

### REFILL CAPACITIES

Fluid	Ford Part Name	Application	Capacity
Engine oil (includes filter change)	Motorcraft 5W30 Super Premium Motor Oil	All	5.7L (6.0 quarts)
Engine coolant	Ford Premium Cooling System Fluid	All	13.5L (14.25 quarts)
Brake fluid	High Performance DOT 3 Motor Vehicle Brake Fluid	All	Fill to line in reservoir
Power steering fluid	Motorcraft MERCON® ATF	All	Fill to line in reservoir



## Capacities and specifications

Fluid	Ford Part Name	Application	Capacity
Fuel tank	N/A	All	75.7L (20.0 gallons)
Automatic transaxle	Motorcraft MERCON®V ATF	All	13.0L (13.7 quarts)
Windshield washer fluid	Ultra-Clear Windshield Washer Concentrate	All	Fill to line in reservoir

## LUBRICANT SPECIFICATIONS

Item	Ford Part Name or equivalent	Ford Part Number	Ford Specification
Brake fluid	High Performance DOT 3 Motor Vehicle Brake Fluid	C6AZ-19542-AB	ESA-M6C25-A and DOT 3
Door latch, hood latch, auxiliary latch, seat tracks, trunk latches	Multi-Purpose Grease	DOAZ-19584-AA or F5AZ-19G209-AA	ESB-M1C93-B or ESR-M1C159-A
Lock cylinders	Penetrating Lubricant	E8AZ-19A501-B	N/A
Automatic transaxle (AX4N)	Motorcraft MERCON®V ATF	XT-5-QM	MERCON®V

## Capacities and specifications

Item	Ford Part Name or equivalent	Ford Part Number	Ford Specification
Engine oil	Motorcraft 5W30 Super Premium Motor Oil	XO-5W30-QSP	WSS-M2C153-G and API Certification Mark
Constant velocity joints	CV Joint Grease (High Temp.)	E43Z-19590-A	ESP-M1C207-A
Engine coolant	Ford Premium Cooling System Fluid	E2FZ-19549-AA	ESE-M97B44-A
Power steering fluid	Motorcraft MERCON® ATF	XT-2-QDX	MERCON®
Windshield washer fluid	Ultra-Clear Windshield Washer Concentrate	C9AZ-19550-AB	ESR-M17P5-A

### ENGINE DATA

Engine	4.6L DOHC V8 engine
Cubic inches	281
Horsepower	260 @ 5500 rpm
Torque	272 lb. ft. @ 4500 rpm
Recommended fuel grade (R + M)/2	91 octane
Firing order	1-3-7-2-6-5-4-8
Spark plug gap	1.3-1.4 mm (0.052-.056 inch)
Ignition system	EDIS
Compression ratio	9.8:1

## Capacities and specifications

### VEHICLE DIMENSIONS

Vehicle dimensions	mm (in)
(1) Overall length	5 294.7 (208.4)
(2) Overall width	1 870.3 (76.3)
(3) Overall height	1 421.9 (55.9)
(4) Wheelbase	2 769.8 (109.0)
(5) Track - Front	1 600.2 (63.0)
(5) Track - Rear	1 562.1 (61.5)

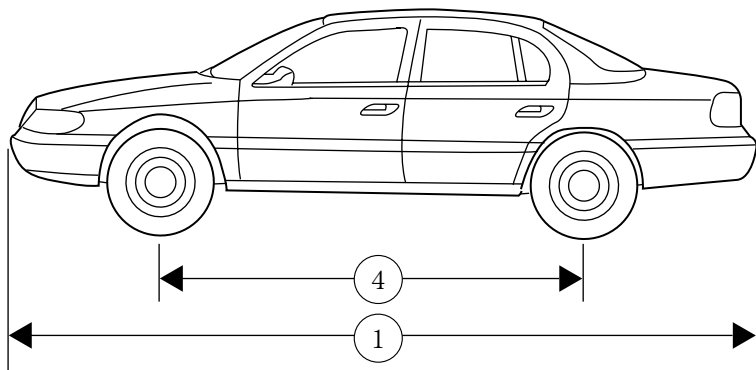

# Capacities and specifications

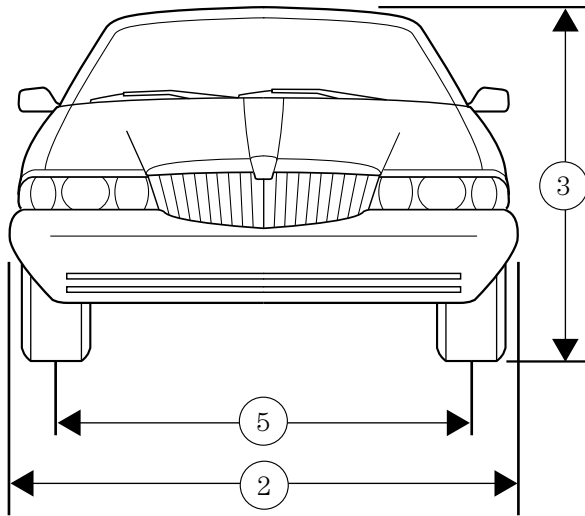

## IDENTIFYING YOUR VEHICLE

### Safety compliance label

The National Highway Traffic Safety Administration Regulations require that a Safety Compliance Certification Label be affixed to a vehicle and prescribe where the Safety Compliance Certification Label may be located. The Safety Compliance Certification Label is located on the front door latch pillar on the driver's side.

<b>MFD. BY FORD MOTOR CO. IN U.S.A.</b>									
DATE: XXXXX					GVWR: XXXXX LB/ XXXXX KG				
FGAWR: XXXXXX/XXXXXXXX					RGAWR: XXXXXX/XXXXXXXX				
THIS VEHICLE CONFORMS TO ALL APPLICABLE FEDERAL MOTOR VEHICLE SAFETY STANDARDS IN EFFECT ON THE DATE OF MANUFACTURE SHOWN ABOVE.									
VIN: XXXXXXXXXXXXXXXXXXXX					TYPE: XXXXXXXXXXXXXXXXXXXX				
MAXIMUM LOAD=OCCUPANTS + LUGGAGE=XXXKG/XXXLB									
OCCUPANTS: X TOTAL X FR X 2ND X RR OCCUPANTS LUGGAGE									
XX XXXKG/XXXLB									
X XXXKG/XXXLB									
TIRE: XXXX/XXXX XXX									
PRESSURE (FR) XXX kPa/33 PSI COLD									
PRESSURE (RR) XXX kPa/33 PSI COLD									
TRAILER TOWING - SEE OWNER GUIDE									
EXT PNT: XXXXXX XXXXXX		RC: XX		DSO: XXXX		F0000			
BAR	INT	TR	TP/PS	R	AXLE	TR	SPR	T0000	
X	XX	XXX	X	XX	X	XXXX			
UTC VFOHT-15294A-10-GA									

## Capacities and specifications

### Vehicle identification number

The vehicle identification number is attached to a metal tag and is located on the driver side instrument panel.



### ENGINE NUMBER

The engine number (the last eight numbers of the vehicle identification number) is stamped on the engine block, transmission, frame and transfer case (if so equipped).

## Reporting safety defects

### REPORTING SAFETY DEFECTS (U.S. ONLY)

If you believe that your vehicle has a defect that could cause a crash, or could cause injury or death, you should immediately inform the National Highway Traffic Safety Administration (NHTSA) in addition to notifying Ford Motor Company.



If NHTSA receives similar complaints, it may open an investigation, and if it finds that a safety defect exists in a group of vehicles, it may order a recall and remedy campaign. However, NHTSA cannot become involved in individual problems between you, your dealer or Ford Motor Company.

To contact NHTSA, you may either call the Auto Safety Hotline toll-free at 1-800-424-9393 (202-366-0123 in the Washington D.C. area) or write to:

NHTSA  
U.S. Department of Transportation  
400 Seventh Street  
Washington D.C. 20590

You can also obtain other information about motor vehicle safety from the Hotline.

- Air bag supplemental restraint system .....80
  - and child safety seats .....81
  - description .....80
  - disposal .....83
  - indicator light .....82
  - passenger air bag .....81
- Air suspension
  - description .....98
- Anti-lock brake system (ABS)#\$description
- Anti-theft system .....63
- Battery .....136
- Brakes .....95
  - anti-lock .....95
  - anti-lock brake system (ABS)
    - warning light .....95
  - fluid, checking and adding ...130
  - traction control .....97
- Brake-shift interlock .....99
- Break-in period .....2
- Bulbs, replacing .....150
  - headlamps .....150
  - specifications .....154
- Changing a tire .....119
- Child safety seats .....84
- Childproof locks .....61
- Chime
  - headlamps on .....9
- Cleaning your vehicle .....155
  - engine compartment .....156
  - instrument panel .....157
  - plastic parts .....157
  - safety belts .....157
  - tail lamps .....157
  - washing .....155
  - waxing .....155
  - wheels .....156
  - windows .....159
  - woodtone trim .....158
- Climate control system
  - automatic temperature control .....27,28,29,30,31,32
- Clock .....33
- Compass, electronic .....55
  - calibration .....57
  - set zone adjustment .....56
- Controls .....62
- Electronic sound system .....62
- Emission control system .....149
- Engine .....162
  - service points .....127
- Engine block heater .....93
- Engine coolant
  - checking and adding .....131,132
  - disposal .....133
  - refill capacities .....133
- Engine oil .....128,129
  - changing oil and oil filter .....130
  - checking and adding .....128,129
- Exhaust fumes .....93
- Floor mats .....63
- Fuel
  - calculating fuel economy .....148
  - improving fuel economy .....108
  - octane rating .....147
  - quality .....147
  - running out of fuel .....148
  - safety information relating to automotive fuels .....146
- Fuel gauge .....10
- Fuel pump shut-off switch .....109
- Fuse panels
  - instrument panel .....110
  - power distribution box .....117
- Fuses .....109,110
- Gauges, Mechanical .....10
  - engine coolant temperature gauge .....11
- Headlamps
  - autolamp system .....27
  - flashing .....26

# Index

- high beam .....26
- Heating .....27
- High beams
  - indicator light .....8
- Hood
  - release lever .....127
- Ignition
  - positions of the ignition .....34
- Jump-starting your vehicle .....122,  
123
  - attaching cables .....123
  - disconnecting cables .....124
- Keyless entry system
  - autolock .....70
  - keypad .....68
  - programming entry code .....68,  
69,70
- Keys
  - key in ignition chime .....9
- Lamps
  - interior lamps .....40,154
  - map lamps .....40
- Lights, warning and indicator
  - air bag .....7
  - anti-lock brakes (ABS) .....8
  - brake .....7
  - charging system .....8
  - oil pressure .....9
  - safety belt .....7
  - service engine soon .....6
  - turn signal indicator .....8
- Lubricant specifications .....161
- Message center .....12
  - date/economy button .....15
  - menu button .....16,17,18,19
  - reset button .....16
  - system check button .....13
  - warning messages .....13
- Mirrors
  - automatic dimming rearview  
mirror .....57
  - cleaning .....159
  - heated .....61
  - side view mirrors (power) .....60
- Moon roof .....52
- Odometer .....10
- Panic alarm feature, remote  
entry system .....66
- Parking brake .....96
- Parts (see Motorcraft parts) ....160
- Power door locks .....58
- Power steering
  - fluid, checking and adding ....134
- Refill capacities for fluids .....160
- Relays .....109
- Remote entry system .....65
  - illuminated entry .....67
  - locking/unlocking doors .....65
  - replacement/additional  
transmitters .....67
  - replacing the batteries .....66
- Reporting safety defects .....166
- Safety restraints
  - automatic locking mode  
(retractor) .....75,76
  - extension assembly .....78
  - for children .....83
  - lap and shoulder belts .....74,75
  - maintenance .....79
  - proper use .....73
  - warning light and chime ..9,78,79
- Safety seats for children
  - attaching with tether straps ....88
  - automatic locking mode  
(retractor) .....85
  - in rear seat .....88
  - tether anchorage hardware ....88
- Seats .....71
  - adjusting the seat, power .....71
  - head restraints .....71
  - heated seats .....73
  - lumbar support .....73
- Servicing your vehicle .....126
  - precautions when servicing ...126



- Speed control .....36
  - canceling a set speed .....39
  - resuming a set speed .....39
  - tap up/tap down .....38
  - turning off .....37
- Speedometer .....10
- Starting your vehicle .....90,92
- Sunvisor .....52
- Tachometer
  - mechanical cluster .....11
- Tilt steering wheel .....40
- Tires .....142,144
  - changing .....119
  - checking the pressure .....144
  - replacing .....145
  - rotating .....144
  - snow tires and chains .....145
  - treadwear .....143
- Traction control
  - off light .....9
- Trailer towing .....105
  - tips .....107
- Transaxle .....99
  - automatic operation .....100,101,  
102,103
- Transmission .....134
  - fluid, checking and adding  
(automatic) .....134
- Trunk
  - using the remote entry  
system to open .....66
- Turn signal
  - lever .....35
- Universal transmitter .....52
  - erasing channels .....55
  - operating .....54
  - programming .....53
- Vehicle dimensions .....163
- Vehicle headlamp aiming
  - device (VHAD) .....152
- Vehicle Identification Number  
(VIN) .....165
- Vehicle loading .....104
- Ventilating your vehicle .....94
- Warning chimes .....6
- Wheels
  - anti-theft lug nuts .....121
- Windows
  - accessory delay .....60
  - power windows, operating .....59
- Windshield washer fluid and  
wipers
  - checking and adding fluid .....131
  - checking and replacing wiper  
blades .....139
  - operation .....34
- Wrecker towing .....124













## Filling station information

Recommended fuel	Unleaded fuel only - 91 octane (R+M/2)
Fuel tank capacity	75.7L (20.0 gallons)
Engine oil capacity (with filter change)	5.7L (6.0 quarts). Use Motorcraft 5W30 Super Premium Motor Oil, Ford Specification WSS-M2C153-G
Automatic transaxle fluid capacity	13.0L (13.7 quarts). Use Motorcraft Mercon <sup>™</sup> V ATF (part# XT-5-QM), Ford Specification WSS-M2C202-B
Tire size and pressure	Refer to Tire Pressure Decal on passenger's door panel
Hood release	Pull handle under the left side of the instrument panel
Coolant capacity	13.5L (14.25 quarts)
Power steering fluid capacity	Fill to line in reservoir

Ensure correct automatic transmission fluid is used for a specific application. Check the container to verify the fluid is MERCON<sup>®</sup> and/or MERCON V<sup>®</sup> approved. Some fluids have been approved as meeting both MERCON<sup>®</sup> and MERCON<sup>®</sup> V requirements and will be labeled as such. Fluids labeled as meeting only MERCON<sup>®</sup> or only MERCON<sup>®</sup> V requirements must not be used interchangeably. DO NOT mix MERCON<sup>®</sup> and MERCON<sup>®</sup> V. Transmission fluid requirements are indicated on the dipstick or on the dipstick handle. Refer to your "Service Guide" to determine the correct service interval.